

QUEST RJ

ISSN 1605-8607  
Bi-Annual

**QUAID-E-AWAM UNIVERSITY  
RESEARCH JOURNAL  
of Engineering, Science & Technology**



**MISSION STATEMENT OF QUEST**

“To provide quality and state-of-the art education (coursework, practical training and research) in prescribed branches of Engineering and Science to the enrolled students in order to make them better professionals and better human being; so that they become capable of contributing amicably towards national development”.

**PUBLISHED BY:**  
Directorate of Research & Publication,  
Quaid-e-Awam University of Engineering,  
Science & Technology (QUEST), Nawabshah  
District Shaheed Benazirabad, Sindh-Pakistan

Phone #: 92-244-9370544  
Fax #: 92-244-9370362  
email: editor\_rj@quest.edu.pk

*Designed by:*  
UROOJ GRAPHICS  
Court Road Nawabshah  
Cell. # 0300-3773657

Volume 14

No: 2

JULY - DECEMBER 2015

BI-ANNUAL

ISSN 1605-8607

# QUAID-E-AWAM UNIVERSITY RESEARCH JOURNAL OF ENGINEERING, SCIENCE & TECHNOLOGY



## **EDITORIAL BOARD**

**Professor Dr. Abdul Karim Baloch**

Chief Patron  
Vice-Chancellor

**Professor Dr. Saleem Raza Samo**

Editor-in-Chief  
Department of Energy & Environment Engineering

**Dr. Syed Raheel Hassan**

Editor  
Department of Computer Systems Engineering

MEMBERS (INLAND)	MEMBERS (ABROAD)
<b>Professor Dr. Bashir Ahmed Memon</b> Dean Faculty of Engineering	<b>Ms. Marry Hancock</b> U.K
<b>Professor Dr. Abdullah Saand</b> Dean Quality Enhancement Cell	<b>Dr. Iftikhar Raja</b> U.K
<b>Professor Dr. Muhammad Usman Keerio</b> Dean Faculty of EL, ES, CSE & TC	<b>Dr. Muhammad Riaz Khan</b> Canada
<b>Professor Dr. Abdul Fattah Chandio</b> Department of Electronic Engineering	<b>Dr. Syed Tanveer Wasti</b> Turkey
<b>Professor Dr. Zahid Hussain Abro</b> Dean Faculty of Science	<b>Farid Nasir Ani</b> Malaysia
<b>Professor Dr. Liaquat Ali Memon</b> Department of Mechanical Engineering	<b>Dr. Muhammad Bin Ismail</b> Malaysia
<b>Engr. Abdul Nasir Laghari</b> Department of Energy and Environment Engineering	<b>Prof. Li Jinlin</b> China

ANNUAL SUBSCRIPTION..... RS. 200.00 (INLAND), US\$ 20.00 (FOREIGN, BY SURFACE MAIL)

SINGLE ISSUE.....RS. 100.00 (INLAND), US\$ 10.00 (FOREIGN, BY SURFACE MAIL)

The Bi-Annual Quaid-e-Awam University Research Journal of Engineering, Science & Technology, shall be supplied free of cost in exchange of Research Journal(s) from other Universities/Institutions and Research Centers.

## ACKNOWLEDGEMENT

The members of Editorial Board, Quaid-e-Awam University Research Journal of Engineering, Science & Technology are grateful for valuable and critical suggestions on various research paper(s) sent to following Researchers/Experts for Volume 14, No. 2, July – December 2015 issue. The members also appreciate the Referees/Experts for sharing their knowledge and expertise towards improvement of standard of this research Journal.

**Prof. Dr. Wasi Z. Khan**

Chemical Engineering,  
Nazerbayev University,  
Republic of Kazakstan

**Dr. Dheerendra Singh**

Chemical Engineering Department  
Middle East Technical University, Ankara,  
Turkey

**Dr. Nadeem Ahmed**

Department of Computing,  
National University of Sciences and  
Technology (NUST), Pakistan

**Dr. Matthias Waechter**

Carl von Ossietzky University  
Oldenburg, Germany

**Prof. Dr. Abdul Jabbar Laghari**

Dr. M. A. Kazi Institute of Chemistry,  
University of Sindh, Pakistan

**Dr. Diptiranjana Behera**

University of Electronic Science and  
Technology, China

**Prof. Dr. Abdul Fatah Abbasi**

Mehran University of Engineering  
Technology, Jamshoro, Pakistan

**Muhammad Umar Muhammad Ali,**

Mechanical Engineering Department  
University of California, USA

**Dr. Aamna Rehmat Awan**

Punjab Institute of Contemporary  
Sciences, Lahore, Pakistan

**Dr. Nasreen Bano**

Quality and Safety Assessment,  
Research Unit Athens, Georgia, USA

**Prof. Dr. Mohammed Reza Rahimi Tabar**

Sharif University of Technology,  
Tehran, Iran

**Dr. Hassan Imran Afridi**

Center of Excellence in Analytical  
Chemistry Jamshoro, Sindh, Pakistan

**Prof. Dr. Mushtaque Ali**

Shah Abdul Latif University Khairpur,  
Sindh, Pakistan

**Dr. Nor'ain Mohd Yusoff**

Faculty of Computing and Informatics,  
Multimedia University, Malaysia

**Dr. Noman Qadeer**

DHA Suffa University, Karachi,  
Pakistan

**Dr. Mahmood Shah**

Senior Lecturer,  
Lancashire Business School,  
University of Central Lancashire, UK

**Prof. Dr. Kamran Raza**

Dean of Engineering,  
Iqra University, Karachi,  
Pakistan

**Mr. Manzoor Ahmed**

Manager Oil and Gas Development  
Company Limited, Islamabad,  
Pakistan

**Dr. Adnan Tariq**

Associate Professor,  
Mechanical Engineering Department,  
WAH Engineering College, Wah Cant,  
Pakistan

**Adeel Nazeer**

Senior Geologist (PPL) & Certified  
Professional Geologist (AIPG),  
Pakistan Petroleum Limited, Islamabad,  
Pakistan

**Dr. Ghous Bux Narejo**

Associate Professor,  
Department of Electronics Engineering,  
NED University, Karachi,  
Pakistan

**Ahmed Raza**

Assistant Professor,  
Industrial Engineering Department,  
UET Lahore, Pakistan

## CONTENTS

VOLUME 14	NO. 2	JULY - DECEMBER 2015
1. <b>Mechanical Characterization of Locally Developed Composite Materials Using VARTM System</b> Mushtaque Ahmed Lakho, Altaf Hussain Rajpar, Muhammad Ramzan Luhur, Abdul Latif Manganhar.....		01
2. <b>Analysis of Wind Flow Diverting and Accelerating Characteristics of Porous and Non-Porous Circular Obstacles</b> Abdul Latif Manganhar, Muhammad Ramzan Luhur, Altaf Hussain Rajpar, Saleem Raza Samo.....		06
3. <b>Simulation and Mathematical Modelling of Power Line Communication Channel for High Data Transfer Rate</b> Nanik Ram Parhyar, Madad Ali Shah, Mir Mohammad Lodro.....		13
4. <b>Antioxidant Activity and Total Phenolics Content of Extracts from <i>Murraya Koenigii</i> (Curry Leaves), <i>Laurus Nobilis</i> (Bay Leaves), and <i>Camellia Sinensis</i> (TEA)</b> Shagufta Ishtiaque, Shahina Naz, Noorullah Soomro, Kehkashan Khan, Rahmanullah Siddiqui.....		20
5. <b>Analysis of Physicochemical and Biological Quality Parameters of Phuleli Canal Water and Wastewater Adjacent to Hyderabad City</b> Sikandar Ali Channa, Abdul Qayoom Jakhrani, Kishan Chand Mukwana, Sadam Hussain Jakhrani.....		26
6. <b>Medicinal Plants' Use in and Around Kalinzu Central Forest Reserve, Bushenyi – Western Uganda</b> Mumtaz Ahmed Sohag, Musinguzi Danson.....		34
7. <b>Power Flow Enhancement of 220 KV Transmission Line With Unified Power Flow Controller</b> Muhammad Waqas, Najeeb-ur-Rehman, Kashif Hussain, Rameez Akbar Talani, Jamshed A. Ansari.....		40
8. <b>ALL-RE: A Model For Teaching And Learning Requirements Engineering</b> Rafia Naz Memon, Irfana Memon, Shah Zaman Nizamani, Fiza Siyal, Pardeep Kumar.....		45
9. <b>Cogeneration Technology: Cleaner and Environment Friendly</b> Zeenat M.Ali, M. M. Tunio, A. J. Laghari, A.Q Laghari.....		54
10. <b>Impact of Urban and Industrial Effluent of Hyderabad City on Fresh Water Pinyari Canal</b> Ali Asghar Mahessar, Abdul Latif Qureshi, Kishan Chand Mukwana, Abdul Nasir Laghari.....		57
11. <b>Comparative Analysis of Weather Parameters at Two Locations for Viability of Solar Energy Systems</b> Abdul Qayoom Jakhrani, Andrew Ragai Henry Rigit, Muhammad Moosa Jakhrani, Sikandar Ali Channa.....		64
12. <b>Ground Water Quality of Khairpur Mir's Sindh: A Case Study</b> Zeenat M.Ali, Zulfiqar Ali Bhatti, Kishan Chand Mukwana, M.M Tunio.....		69
13. <b>Identification of Unconventional Shale-Gas Plays and Reservoir Characterization Through <math>\Delta</math>LOGR Method and Well LOG Interpretation : A Case Study From Lower Indus Basin, Pakistan</b> Bilal Aslam, Shazia Asim, Shabeer Ahmed Abbasi, Sarfraz Hussain Solangi, Saad Khurshid.....		72
14. <b>Continuous Wavelet Transforms for Delineation of Thin Sand Reservoirs of Miano Area, Southern Indus Basin, Pakistan</b> Muhammad Tayyab Naseer, Shazia Asim, Shabeer Ahmed Abbasi, Sarfraz Hussain Solangi, Faisal Munawar....		82
15. <b>Agile Manufacturing in Seasonal Demanded SME's</b> Tishawar Sharif, Muhammad Farooq, Hassan Farooq, Muhammad Tayyab.....		91

# MECHANICAL CHARACTERIZATION OF LOCALLY DEVELOPED COMPOSITE MATERIALS USING VARTM SYSTEM

Mushtaque Ahmed Lakho\*, Altaf Hussain Rajpar\*\*, Muhammad Ramzan Luhur\*\*\*, Abdul Latif Manganhar\*\*\*

## ABSTRACT

**The world of composite materials is constantly improving by the introduction of new materials with improved characteristics. In this paper, using a locally developed Vacuum Assisted Resin Transfer Moulding (VARTM) system, a composite material specimen (using a local cotton fabric laminated with vinyl ester resin KrF1001) has been developed. The mechanical properties of the developed specimen have been tested with and without reinforcement with vinyl ester resin. The results reflect that the developed composite material specimen acquired significant enhancement in mechanical properties such as tensile strength, modulus of elasticity and break elongation. The specimen is found ductile in nature.**

*Key words: Mechanical characterization, composite materials, VARTM system, tensile strength, modulus of elasticity, break elongation*

## 1. INTRODUCTION

Composite materials have been used to solve technological problems since long, however, significant attention from industrial side started in 1960s with introduction of polymer-based composites. Since then composite materials have been in common practice in the field of engineering. The increased awareness regarding the product performance and the competition in the global market for the light materials also boosted the increased applications of composite materials. The advantages such as low weight, resistance to corrosion and low maintenance cost, made composite materials an attractive alternative to traditional materials such as wood, steel and concrete. In addition, the extensive reaction of composites to harsh environmental conditions reduce the cost associated with expensive maintenance compared to wooden and steel members [1].

The development of biodegradable polymer as thermoplastics stretch (TPS) materials gained much interest in recent years, in particular because of their biodegradability, low cost and wide availability. Nevertheless, TPS has two main limitations; one the poor mechanical properties (i.e. low strength, low flexure strength and low stiffness) compared to advanced fabric reinforced plastic composites, and other the high water absorption rate [2-4].

The fabric-reinforced composite materials exist in two main categories; namely particle reinforced and continuous reinforced materials. The continuous reinforced materials often constitute a layered or laminated structure, whereas the particle reinforced composites are made from agricultural waste. The latter type is a potential field of composites, but is inferior in mechanical properties compared to commercially

available composite materials. Fabrics for advanced composites are glass fabric, which possess high strength in humid environment, however, degrade under elevated temperature [5-7].

The continuous glass fibbers (the first type of fibbers used in advanced composites) are made by pulling molten glass (at a temperature of about 1300°C) through 0.8-3.0 mm diameter dies and 3-19 mm high-speed stretching [8]. Hybrid composites are made from rubber, wood and coconut shell in combination with textile fabric reinforced with polymer resin. These hybrid composites possess enhanced mechanical properties like tensile strength, modulus of elasticity, impact strength and flexural strength [9].

Natural fabric such as cotton in advanced composite material with polyester resin offers an interesting alternative to petrochemical products. Cotton is mainly used as low cost reinforcement fabric in composites for interior parts of automotive industries and low load bearing structures [10-12].

This paper examines the locally developed composite material prepared with potential use of cotton fabric (CF) with Vinyl ester (VE) resin KrF1001. For this composite material, the cotton fabric was used as reinforcement agent and vinyl ester resin as matrix material. The sample specimen was prepared using locally developed Vacuum Assisted Resin Transfer Moulding (VARTM) system. The scope of this study was to investigate the mechanical properties (such as tensile strength, Young's modulus and tensile elongation) of the proposed composite material through experiments.

The paper is structured like Section 2 describes the methodology, Section 3 presents the results and Section 4 concludes the work.

\* Lab Demonstrator, Quaid-e-Awam University of Engineering, Science and Technology, Nawabshah, Pakistan.

\*\* Professor, Quaid-e-Awam University of Engineering, Science and Technology, Nawabshah, Pakistan.

\*\*\* Assistant Professor, Quaid-e-Awam University of Engineering, Science and Technology, Nawabshah, Pakistan.

## 2. METHODOLOGY

### 2.1. Development of VARTM System

VARTM is a special method used in modern industries to form material. Products made by VARTM system are applicable from home decorative piece to a complex space shuttle advance technology. For present study, VARTM was locally developed in the mechanical engineering department laboratory, Quaid-e-Awam University of Engineering, Science and Technology, Nawabshah Pakistan. The developed VARTM system is shown in Figure 1.



Figure-1: Locally developed VARTM system. (a) VARTM system, (b) Acrylic sheet mould, (c) Compressor (vacuum pump), and (d) Pressure gauge.

The developed simple mould has dimensions of 152.4 mm length, 152.4 mm width and 1 mm thickness. In this way, the cavity in the mould has square shape of 152.4 X 152.4 mm<sup>2</sup> with thickness of 1 mm. The molten material in this cavity can be poured with the help of vacuum pump to get the final solid shaped material.

### 2.2. Preparation of Composite Material

For the development of composite material, VE and CF (plain 2/2 weave, 0/90<sup>0</sup> oriented) were used. In the first stage, VE was used as matrix material. In the next stage, for the preparation of VE specimen “hardener” was used as reactant agent. When hardener mixed with VE resin, in reaction liquid shaped material changed into solid shape. In the mixture, the amount VE resin taken was 96-99% and hardener 0.5-2%. In the third stage, for the preparation of cotton VE composite, methyl ethyl ketone peroxide (MEKP) was added as catalyst with resin. Again the amount of VE resin was 96-99% and catalyst 0.5-2% in the mixture.

In last, the CF was used as the reinforcement material laid on a waxed surface (bottom transparent acrylic plate of mould). Next, a square frame of sealing sheet fixed on all edges of the same bottom plate, then covered with upper

transparent acrylic plate and tightened the sandwich mould using vices. In this way, a composite sheet specimen of dimensions 152.4 X 152.4 X 1 mm<sup>3</sup> has been developed through VARTM process. For testing purpose, from the developed composite sheet, three strips of size 152.4 mm long, 25.4 mm wide and 1 mm thick, were sheared as shown in Figure 2.

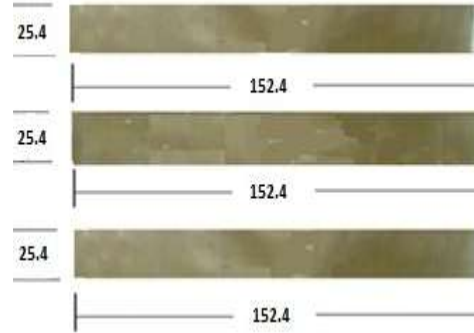

Figure-2: Three sheared strips from developed composite sheet for testing. The dimensions are in mm.

### 2.3. TEST SETUP

The mechanical properties of the developed composite specimen have been examined by conducting standardized tests using a standard SSTM-20KN UTM machine shown in Figure 3. During the test, following three properties have been analysed:

- Tensile Strength (GPa)
- Modulus of Elasticity, MOE (GPa)
- Tensile Elongation (%)

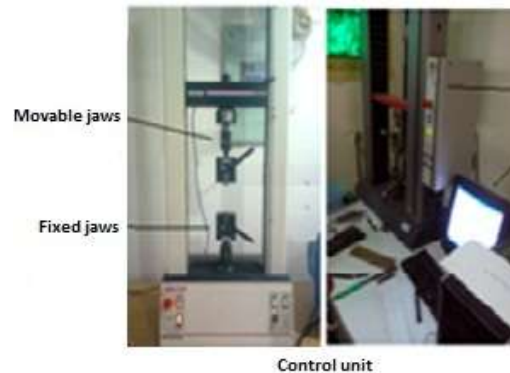

Figure-3: Standard SSTM-20KN UTM machine.

## 3. RESULTS

### 3.1. CF Reinforcement Agent Test

The CF specimen was cut into three pieces of size 152.4 mm long, 25.4 mm wide and 0.27 mm thick. Then three consecutive tests for CF specimens were conducted through standard SSTM-20KN UTM machine to analyse their mechanical properties. Summary of achieved results is given in Table 1.



**Table 1: Tensile test results for CF reinforcement material**

Cotton Fabric 0/90 <sup>0</sup>	Strip 1	Strip 2	Strip 3	Mean
Tensile Strength (GPa)	1261.81	1261.76	1262.00	1261.86
Modulus of Elasticity (GPa)	86.38	80.81	86.38	84.52
Tensile Elongation (%)	7.46	6.96	7.47	7.30

**3.2. COMPOSITE MATERIAL SPECIMEN TEST**

Again using same standard SSTM-20KN UTM machine, CF based reinforced polymer specimen has been tested. Similarly, three consecutive tests for composite material

specimens (each having size 152.4 mm long, 25.4 mm wide and 1 mm thick) have been performed to investigate their mechanical behaviour. The results for composite material are given in Table 2.

**Table 2: Tensile test results for developed composite material**

Cotton Fabric 0/90 <sup>0</sup>	Strip 1	Strip 2	Strip 3	Mean
Tensile Strength (GPa)	1482.63	1482.62	1482.63	1482.63
Modulus of Elasticity (GPa)	470.03	510.40	471.93	484.12
Tensile Elongation (%)	7.46	6.87	7.43	7.25

**3.3. COMPARISON OF CF AND COMPOSITE MATERIAL**

The mechanical properties of the CF reinforcement material given in Table 1 and the composite material given in Table 2, are compared in Table 3. Table 3 shows

the variation between the mean values of the mechanical properties for the mentioned materials. It is obvious that compared to CF, developed composite material found 1.2 times increased in tensile strength, 5.7 times increased in modulus of elasticity and 0.65 times decreased in tensile elongation.

**Table 3: Comparison of mechanical properties between CF reinforcement material and developed composite material**

Properties	CF reinforcement material	Developed Composite Material	Variation
Tensile Strength (GPa)	1261.86	1482.63	Increase 1.2 times
Modulus of Elasticity (GPa)	84.52	484.12	Increase 5.7 times
Tensile Elongation (%)	7.30	7.25	Decrease 0.65 times

**3.4. COMPARISON OF DEVELOPED AND CONVENTIONAL COMPOSITE MATERIAL**

Here, the observed mechanical properties for locally developed composite material are compared with closely related conventional composite materials. The conventional materials include E-Glass (U.D), Kevlar and E-Glass (M.D) reinforced polymer-based composites; see

Figure 4. In these composites thermoset polymer is used as matrix material. The figure shows that compared to conventional composite materials, locally developed composite material gives 1.5-3.4 times improvement in tensile strength, 12.10-19.36 times increase in modulus of elasticity and 2.9- 4.26 times increase in tensile elongation; see (a), (b) and (c), respectively.

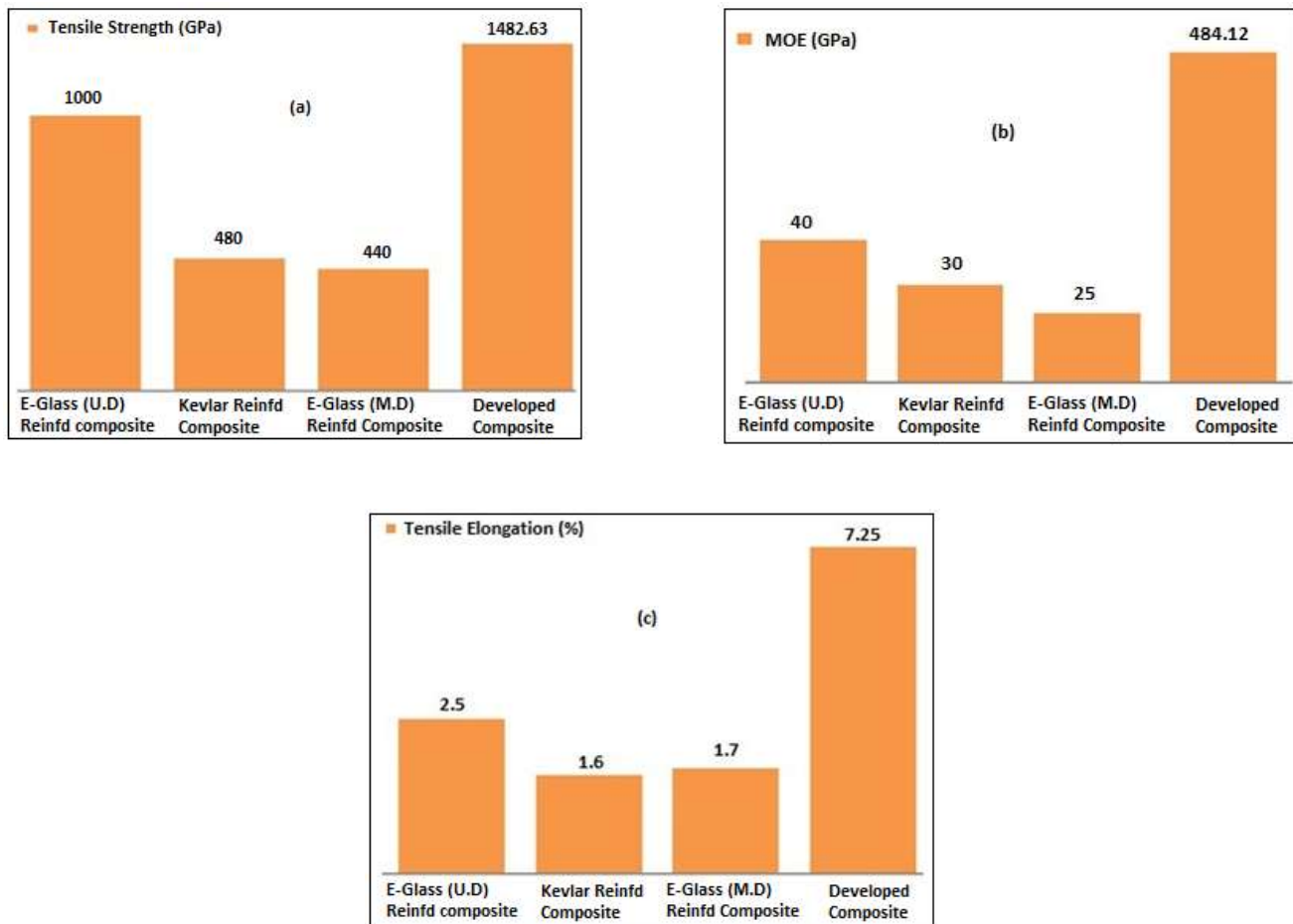

Figure 4: Comparison of mechanical properties between developed composite and conventional materials [13, 14]. (a) Tensile strength (GPa), (b) Modulus of elasticity (GPa), and (c) Tensile elongation (%).

#### 4. CONCLUSION

A composite material using cotton fabric as reinforcement agent with matrix material (vinyl ester resin) has been developed through locally developed VARTM system.

The mechanical properties of the developed composite are analysed using standard SSTM-20KN UTM machine and compared with closely related conventional composites.

The results reflect that the developed composite material acquire significant enhancement in mechanical properties compared to conventional composite materials such as E-glass U.D, Kevlar Fabric and E-glass Fabric. Further, the developed composite material found ductile in nature.

#### ACKNOWLEDGEMENTS

Authors would like to acknowledge the cooperation of Mechanical Engineering Department Laboratories staff, Quaid-e-Awam University of Engineering, Science and Technology, Nawabshah, Pakistan.

#### REFERENCES

- [1] Mazumdar S.K, "Composite Manufacturing Materials, Product and Processing Engineering", Text Book, CRC Press LLC, 2002.
- [2] Lilja J and Salonen P, "Textile material characterization for Software antenna", Military Communications Conference, IEEE, pp. 1- 7, 2009.
- [3] Long A.C, "Design and manufacture of textile composites", Woodhead Publishing Limited, Cambridge England, 2005.
- [4] Ioannis G, Raftoyiannis, "Experimental Testing of Composite Pannels Reinforced with Cotton Fabric", Open Journal of Composite materials, Vol. 2, pp. 31-39, 2012.
- [5] Prachayawarakorn J, Ruttanabus P and Boonson P, "Effect of Cotton Fabric Contents and Lengths on Properties of thermoplastics Starch Composites Prepared from Rice and Waxy Rice Starches", Journal Polymer



Environ, Springer Science + Business Media, Vol. 19, pp. 274-282, 2010.

- [6] Carvelho A.J.F, “Starch Major Source Properties and Applications as thermoplastics materials”, Journal Elsevier, Vol. 1, pp. 231-238, 2008.
- [7] Perepelkin K.E, “Basic Types of Reinforcing Fabric Fillers and Polymer Composites”, Journal of Fabric Chemistry, Vol. 37, pp. 381-395, 2005.
- [8] Agarwal B.D and Broutman L.J, “Analysis and Performance of Fabric Composites (2nd edn)”, John Wiley and Sons, New York, p. 103, 1990.
- [9] Petter S.T, “Hand Book of Composite (2nd edn)”, Chapman and Hall, 1998.
- [10] Agarwal B.D and Broutman L.J, “Analysis and Performance of Fabric Composites (2nd edn)”, John Wiley and Sons, New York, p. 103, 1990.
- [11] Valery V, Vasiliev, Evgeny V and Morozov A, “Hand Book of Mechanics and Analysis of Composite Materials”, Elsevier Science Ltd, 2001.
- [12] Misnon M.I, Bahari S.A and Ahmad W.Y.W, “Mechanical Properties of Textile Fabrics Reinforced Hybrid Composites”, International Conference on Science and Social Research, Kualampr, pp. 809-814, December 2010.
- [13] Taj S, Munawar A. M and Khan S, “Natural Fibre-Reinforced Polymer Composites”, Pakistan Aced Science, Vol. 44, No. 2, pp. 129-144, 2007.
- [14] Rajpar A. H, Manganhar A. L and Shah S. A, “Mechanical Characterization of Cotton/Polyester Composite Materials”, Mehran University Research Journal of Engineering and Technology, Vol. 33, No. 2, pp. 227-238, 2014.

# ANALYSIS OF WIND FLOW DIVERTING AND ACCELERATING CHARACTERISTICS OF POROUS AND NON-POROUS CIRCULAR OBSTACLES

Abdul Latif Manganhar\*, Muhammad Ramzan Luhur\*, Altaf Hussain Rajpar\*\*, Saleem Raza Samo\*\*

## ABSTRACT

Structures and tall buildings in urban environment have been considered responsible factors for generating turbulence and reducing velocity of the wind flow. Thus, the decisions about positioning the wind turbines in urban areas require several factors to consider. Literature review reflects that the wind flow diverting and accelerating characteristics of existing obstacles are less attended. In the present study, wind velocity variations taking place in the exterior local environment of porous and non-porous obstacles (except over the obstacle) are analyzed. To analyze the resulting wind flow characteristics, the simulations have been carried out using ANSYS Fluent, CFD code. The results reflect that optimum velocity magnitude can be achieved in the diverted paths at left and right sides of the obstacles.

**Key words:** wind flow diversion, wind flow acceleration, turbulent flow, porous obstacle, non-porous obstacle, CFD.

## 1. INTRODUCTION

The energy dependent socio-economic development processes, increasing population and energy demand, insufficient and fossil fuel based power generation are the most critical energy concerned issues of the world. Utilization of fossil fuels as energy resource not only contributes to environmental pollution but deplete also [1-4]. In the light of these issues following areas are required to be focused:

- more power generation
- small scale and indigenous technology
- most effective and economical systems
- exploitation of renewable and indigenous environment friendly resources [5-8].

For the built environment, micro generation technology is the preferable choice. In contrast to the traditional centralized energy supply, micro technologies bring power generation close to the user to sustain their buildings. To utilize this technology, estimations suggest a huge potential in the urban environment not only to satisfy the demand and provide the decentralized generation, but also to tackle the fuel shortage as well as to achieve the reduction in emissions [9].

Nevertheless, the developments in the direction of micro technology are limited due to quality of the wind flow in these zones [10]. The observations manifest that the performance of a building mounted wind turbine is strongly dependent on site selection. Further, the site measurements of wind speed require time and money, which are often not available for micro projects [11].

Therefore, sites selected for small scale wind turbines in built environment are often roofs of tall buildings, where less turbulent wind is available.

All structures have aerodynamic characteristics and modify wind flow in their local-environment. These modifications may or may not be beneficial for the locations where the structure exists. Literature reveals the study of roof top small scale wind turbine characteristics, nevertheless, the characteristics of such installations at other sides of the building are less investigated.

In the present study wind velocity variations taking place in the exterior local environment of porous and non-porous obstacles (except over the obstacle) are taken into consideration. The simulations are performed using the ANSYS Fluent CFD code to identify the velocity variations and optimum accelerated locations in the diverted flow.

The paper is organized such that Section 2 describes the material and methods, Section 3 presents the results and discussions and the last Section 4 concludes the outcome.

## 2. MATERIALS AND METHODS

In order to specify the wind flow variations, two circular obstacles, i.e., one solid (non-porous) and other porous having identical dimensions with swept area of 0.24 m<sup>2</sup> were considered, as shown in Figure 1. The solid obstacle is a circular cylinder of diameter 0.8 m and height 0.3 m, and the porous obstacle is a circular structure of same size with four walls tilted at angle of 45°. The porous structure provides several paths for wind to flow through it.

\*Assistant Professor, Quaid-e-Awam University of Engineering, Science and Technology, Nawabshah, Pakistan.

\*\*Professor, Quaid-e-Awam University of Engineering, Science and Technology, Nawabshah, Pakistan.

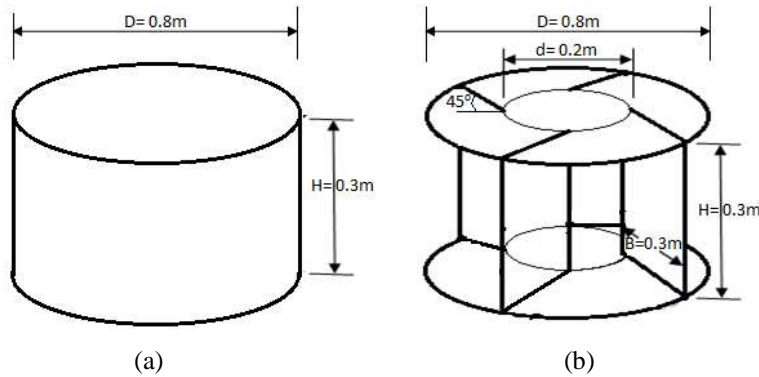

Figure-1: Obstacles to wind flow, (a) solid obstacle and (b) porous obstacle

## 2.1. CFD SIMULATIONS

The CFD simulations are performed using the student version of Ansys fluent 14.5. The flow behavior over the obstacles (described in Section 2) is analyzed through RANS model; the SST K- $\omega$  at wind speed of 5 m/s. The

computational domain for present simulations is given in Figure 2, where diameter D is 0.8 m. The boundary conditions for this domain are described in Table 1. The meshing for computational domain was performed using Quad/Tri:Pave meshing scheme.

Table 1: Wall boundary conditions

Inlet boundary conditions		Outlet boundary conditions	
Type	Velocity inlet	Type	Pressure outlet
Reference Frame	Absolute	Gauge pressure	0
Coordinate System	Cartesian	Backflow direction specification method	Normal to boundary
X-Velocity (m/s)	5	Turbulence specification method	K and Omega (SST)
Y-Velocity (m/s)	0	Backflow turbulent intensity (%)	5
Z-Velocity (m/s)	0	Back flow turbulent viscosity ratio	10
Turbulence specification method	K and Omega (SST)	-	-
Turbulent intensity (%)	5	-	-
Turbulent viscosity ratio	10	-	-

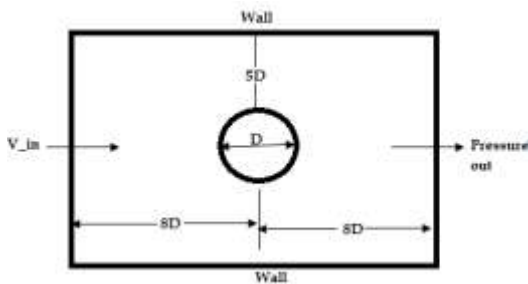

Figure-2: Computational domain for simulations.

## 2.2. THEORETICAL ANALYSIS

The wind at the entrance of a path between two buildings becomes compressed, where pressure increases and velocity decreases. However, after entering (wind flow) into the mentioned path, the flow velocity increases due to pressure difference between the upstream and downstream sides of the buildings. According to Bernoulli's principle, the wind speed along a path between two obstacles increases considerably [12].

Here, we place a circular obstacle into a flow channel as shown in Figure 3, where  $A_1$  represents the upstream wind channel cross-sectional area at Section 1 and  $A_2$  the cross-sectional area at Section 2. The cross-sectional area at Section 2 reduces due to existence of an obstacle in flow path. According to Bernoulli's principle:

$$A_1 V_1 \rho_1 = A_2 V_2 \rho_2 = \text{constant} \quad (1)$$

Where  $V_1$  and  $V_2$  are the flow velocities, and  $\rho_1$  and  $\rho_2$  are fluid densities at Sections 1 and 2, respectively. For low

wind speeds, i.e., less than 100 m/s, the change in density is negligible [13]. In this context, equation (1) can be written as:

$$V_2 = (A_1/A_2) V_1 \quad (2)$$

Equation (2) reflects that for any contraction ratio ( $A_1/A_2$ )  $> 1$ , there is increase in  $V_2$ . This local increase in flow velocity is contributed by the obstacle.

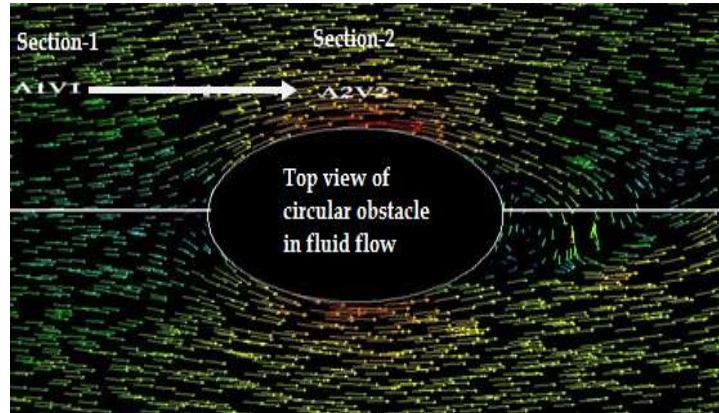

Figure-3: Two-dimensional view of a circular obstacle in a flowing fluid in CFD.

The focus of present research work is to study the magnitude of diverted flow, increase in flow velocity and the location of optimum velocity with turbulent level.

### 3. RESULTS AND DISCUSSIONS

#### 3.1. Solid Circular Obstacle

To understand the effects of obstacle on wind flow and to determine the optimum velocity location in the new flow path, both the turbulence intensity and the magnitude of

velocity (in stream wise direction) were analyzed. The obstacle effect on the wind flow can be visualized clearly through velocity vectors and contour lines, as shown in Figure 4, which reflect the asymmetric flow due to blockage effect of the obstacle. The flow experiences the compression effect which causes reduction in velocity as it comes closer to obstacle. The flow diverts the path following the wall of obstacle (here wall of the obstacle reduces the flow channel width and creates venturi effect) and accelerates at either side of the obstacle.

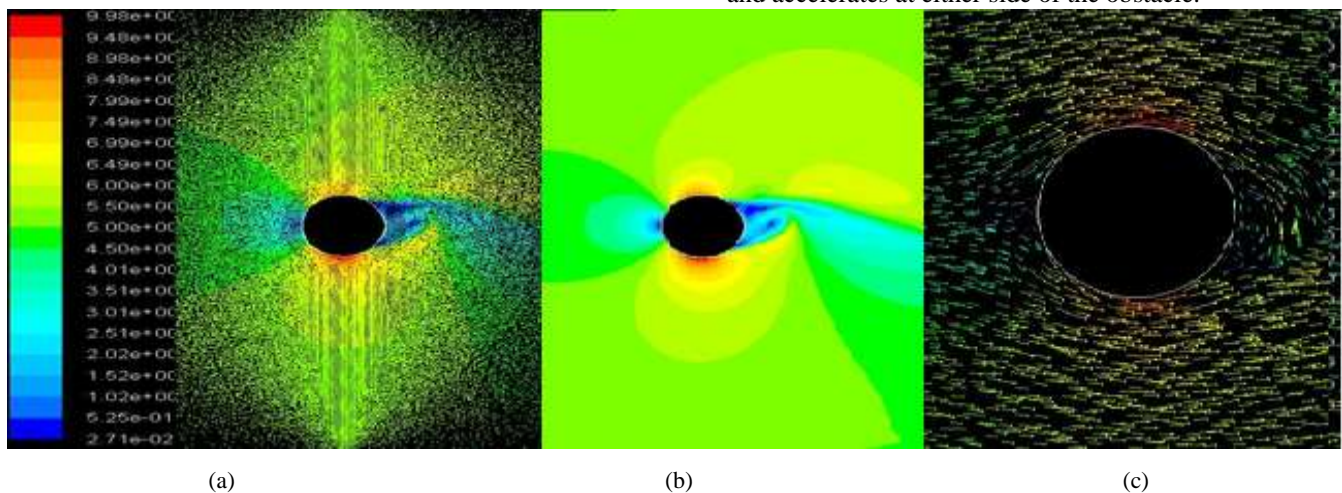

Figure-4: Vectors and contours showing variations in wind velocity magnitude experiencing a solid circular obstacle in its flow path. (a, c) Vectors and (b) contours.

For the width of flow which is equal to  $D/4$ , five streamlines passing through the points P(0,40), P(0,45), P(0,50), P(0,55) and P(0,60) have been considered to observe the effect of obstacle on their velocity. The variations in velocity magnitude along the flow channel are shown in Figure 5, which shows an increase of 4 m/s in upstream wind flow. In other words 5 m/s free stream wind velocity approaches to approximately 9 m/s close to the obstacle P(0,40) after a thin boundary layer.

The magnitude of velocity decreases with increase in width of flow from the obstacle. The streamline passing close to the obstacle achieves maximum velocity of 9 m/s at P(0,40), and the streamline passing at a distance of  $D/4$  from the obstacle achieves maximum velocity of 7 m/s at

P(0,60) as shown in Figure 5. The average velocity magnitude in the selected flow width is approximately 8 m/s, which is an average increase of 62.5% in the free stream flow velocity.

Further, to investigate the flow quality at this location, turbulent intensity and turbulent kinetic energy are estimated given in Figure 6. The contours of turbulent intensity and turbulent kinetic energy exhibit asymmetric behavior of the flow due to same reason described for Figure 4. The figure, for specific considered width of the flow, indicates uniform flow with turbulent intensity of nearly 1% and turbulent kinetic energy less than  $0.25 \text{ m}^2/\text{s}^2$ .

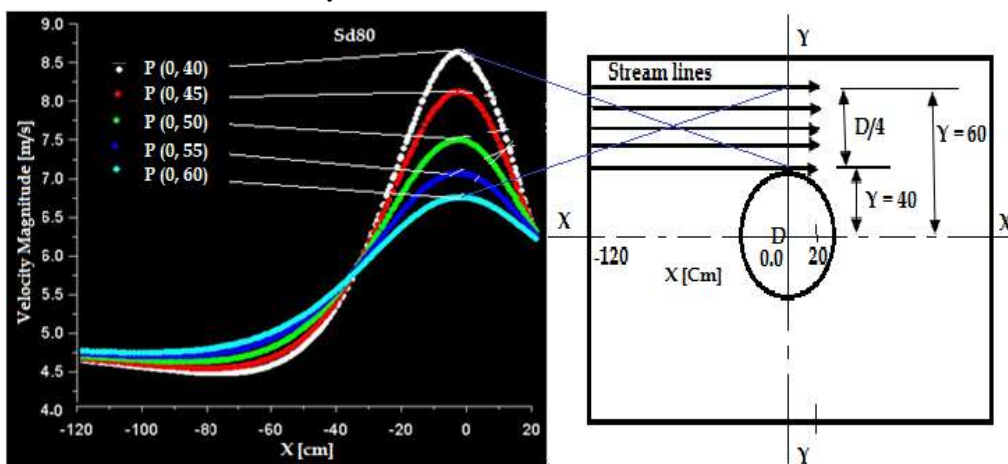

Figure-5: Variations in wind velocity magnitude along five horizontal lines (at  $Y = 40, 45, 50, 55, 60$  cm) drawn parallel to each other in stream wise direction at left side of the solid obstacle.

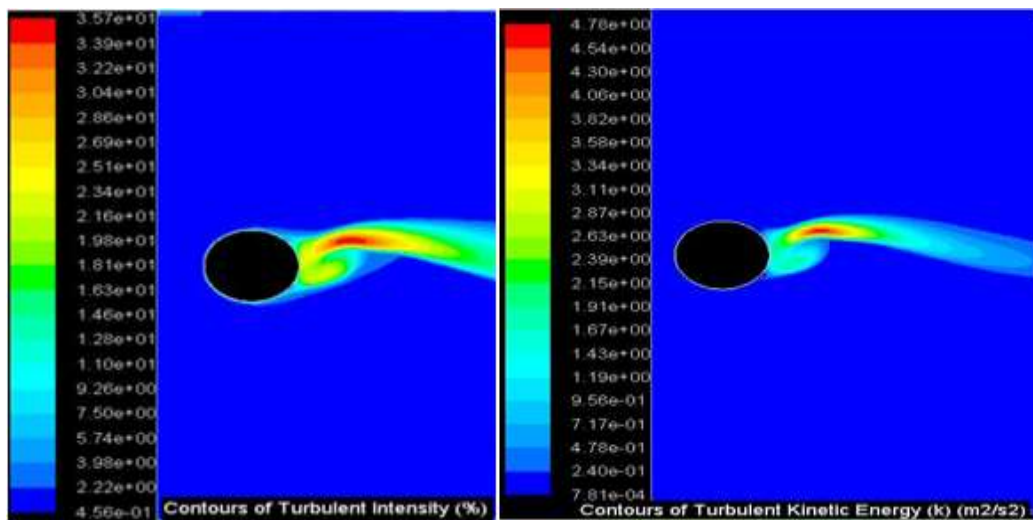

Figure-6: Contours of turbulent intensity and turbulent kinetic energy showing quality of flow around the solid circular obstacle.

### 3.2. POROUS CIRCULAR OBSTACLE

The velocity vectors and contours for porous circular obstacle are shown in Figure 7, which exhibit almost

similar behavior of wind flow as it was observed for solid circular obstacle (see Figure 6). The cross sectional area of wind flow, which is equal to the projected area of



obstacle, interacting with obstacle structure, follows the paths available inside the structure. Here, flow also experiences the compression effect and reduction in wind velocity close to the obstacle as observed in solid circular

obstacle case. Nevertheless, being porous obstacle, it allows part of the flow to pass through it. The rest of the flow diverts the path, concentrates and accelerates at either side of the obstacle like in solid obstacle case.

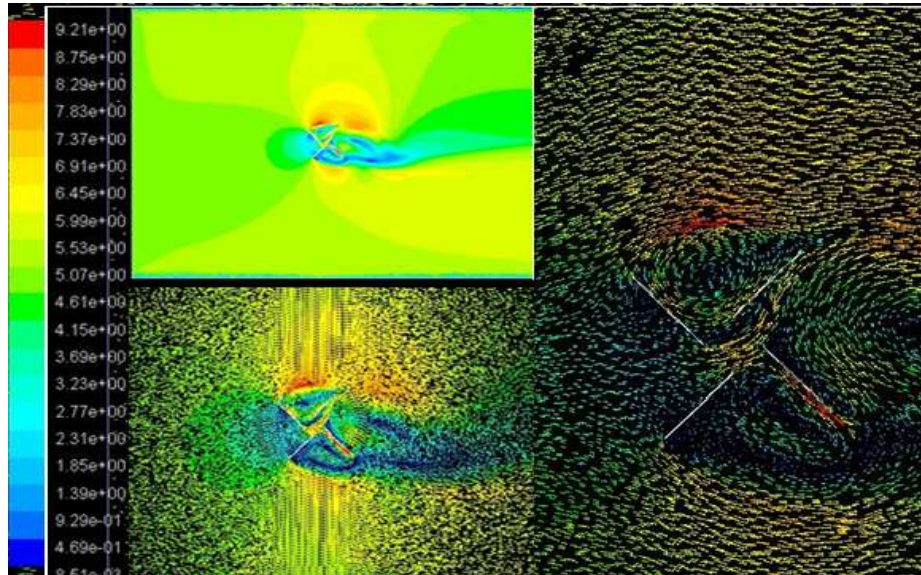

Figure-7: Vectors and contours showing variations in wind velocity magnitude experiencing a porous circular obstacle in its flow path.

Similarly, as in solid obstacle case, the magnitude of velocity decreases with increase in width of flow from the obstacle. The maximum velocity close to obstacle at P(0,40) is approximately same 9 m/s, which decreases to 7.4 m/s at distance D/4 at P(0,60) away from the obstacle, as shown in Figure 8. The average velocity magnitude in the selected flow width is approximately 8.2 m/s, which is an average increase of 64% in the free stream flow velocity. Figure 9 describes the quality of flow around a porous circular obstacle. Similarly, the contours of

turbulent intensity and turbulent kinetic energy, here also exhibit asymmetric flow behavior (for the same reason as described for Figures 4 and 6) for the porous obstacle as observed for solid obstacle. Further, the turbulent intensity is approximately 2%, whereas the turbulent kinetic energy is less than 0.25% (see Figure 9). The values represent the spatial average, which can be read from status bar of the Figure 9. Summarizing, the changes in parameters reflect similar behavior in both cases, except slight variations in their magnitudes.

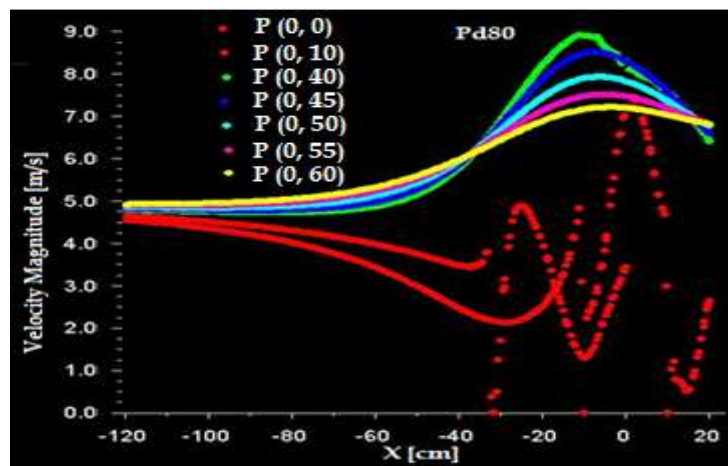

Figure-8: Variations in wind velocity magnitude for seven streamlines in the stream-wise direction passing through the center as well as from left side of the porous obstacle.



The variations in velocity ratio contributed by both obstacles are indicated in Figure 10. The figure reflects nearly similar behavior for wind flow around the porous

and non-porous structures having identical exterior dimensions. The results manifest that such obstacles play a vital role for accelerating wind passing around them.

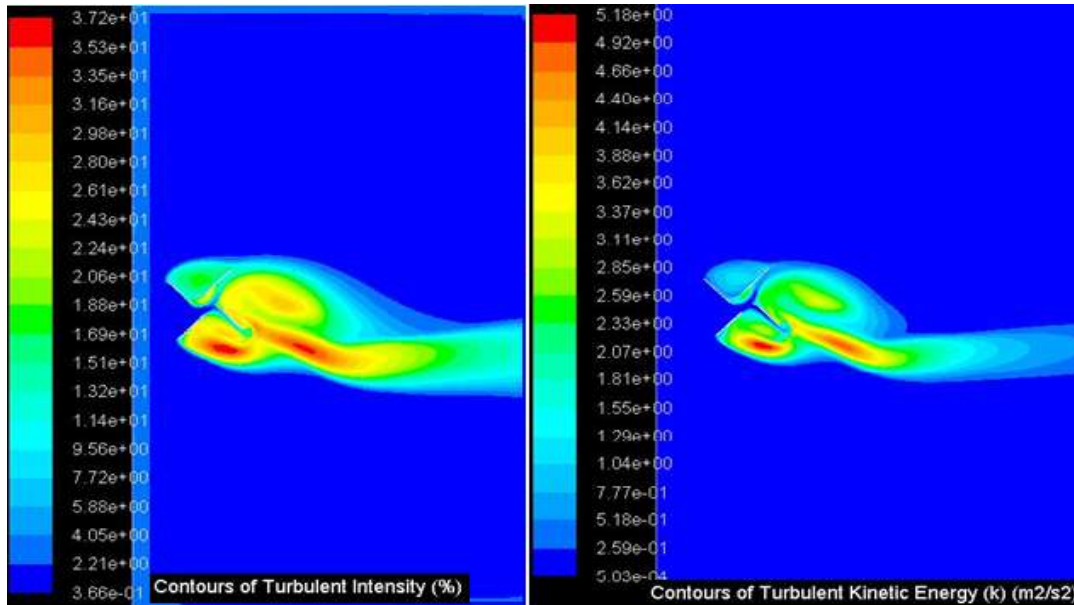

Figure-9: Contours of turbulent intensity and turbulent kinetic energy showing quality of flow around a porous circular obstacle.

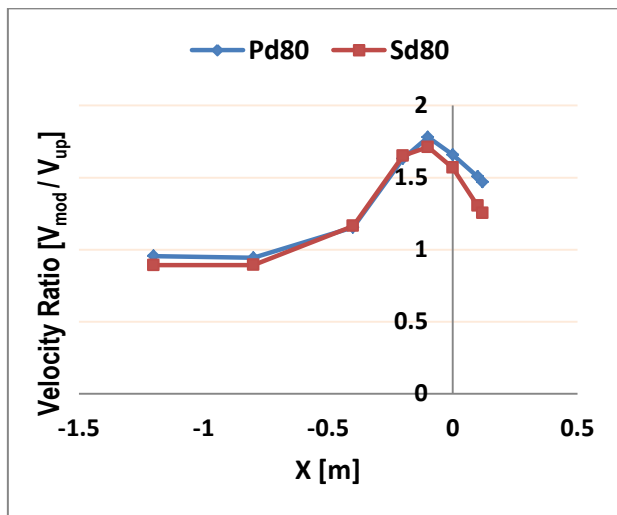

Figure-10: The variations in wind velocity ratio contributed by both porous (Pd80) and solid (Sd80) obstacles describing the behavior of wind passing around them. Here  $V_{mod}$  and  $V_{up}$  represent the modified and upstream flow velocities, respectively.

#### 4. CONCLUSION

The wind velocity variations in the exterior local environment of porous and non-porous circular obstacles (except over the obstacle) have been analyzed using CFD simulations.

The magnitude of velocity decreases with increase in width of flow from an obstacle. For both obstacles, the maximum increase in the velocity over 5 m/s upstream wind is 4 m/s (i.e. increased from 5 m/s to 9 m/s) close to the obstacle after the thin boundary layer. At distance of  $D/4$  from the obstacle, the flow velocity decreases to 7 m/s in case of solid obstacle and 7.4 m/s in case of porous obstacle. The average velocity magnitudes in the selected flow width ( $D/4$ ) are approximately 8 m/s (increase of 62.5%) and 8.2 m/s (increase of 64%), respectively, for solid and porous obstacles. The turbulent intensity is approximately 1% in case of solid obstacle and 2% in case of porous. The turbulent kinetic energy is identical for both obstacles, which is less than  $0.25 \text{ m}^2/\text{s}^2$ .

Summarizing, the changes in parameters reflect similar behavior in both cases, except slight variations in their magnitudes. For both the obstacles, flow experiences the compression and reduction in velocity as it comes closer to the obstacle. Further, flow diverts the path, concentrates and accelerates at either side of the obstacle.

#### ACKNOWLEDGEMENTS

Authors would like to acknowledge the facilities provided by Mechanical Engineering Department, Quaid-e-Awam University of Engineering, Sciences and Technology, Nawabshah.

## REFERENCES

- [1] “Fossil fuel overview”, Ministry of Petroleum and Natural Resources Pakistan, 2005.
- [2] Khanji H, Uqaili M.A and Memon M, “Renewable Energy for Managing Energy Crisis in Pakistan”, IMTIC: 449-455, 2008.
- [3] “Pakistan Statistics”, International Energy Agency (IEA), 2007.
- [4] Sheikh M.A, “Energy and renewable energy scenario of Pakistan”, Renewable and Sustainable Energy Reviews, Vol. 14, pp. 354–363, 2010.
- [5] Islam M, “Design and Development of a Vertical Axis Micro Wind Turbine”, Master thesis, University of Manchester, UK, 2010.
- [6] Eriksson S, Bernhoff H and Leijon M, “Evaluation of Different Turbine Concepts for Wind Power”, Renewable and Sustainable Energy Reviews, Vol. 12, pp. 1419-1434, 2008.
- [7] Wagner H and Mathur J, “Introduction to Wind Energy Systems”, Springer, Germany, ISBN 978-3-642-02022-3, 2009.
- [8] Mathew S, “Wind Energy: Fundamentals, Resource Analysis and Economics”, Springer, Berlin, 2006.
- [9] “Potential for micro generation study and analysis”, Final Report, November 14, 2005.
- [10] Bahaj A.S, James P.A.B, “Urban energy generation: the added value of photovoltaics in social housing”, Renewable and Sustainable Energy Reviews, Vol. 11, No. 9, pp. 2121-2136, 2007.
- [11] Walker S.L, “Building mounted wind turbines and their suitability for the urban scale-A review of methods of estimating urban wind resource”, Energy and Buildings, Vol. 43, pp. 1852–1862, 2011.
- [12] Ragheb M, “OROGRAPHY AND WIND TURBINE SITING”, 2015.
- [13] <http://www.cfd-online.com/Forums/main/8344-incompressible-compressible-flow.html>, accessed June 16, 2015.

# SIMULATION AND MATHEMATICAL MODELLING OF POWER LINE COMMUNICATION CHANNEL FOR HIGH DATA TRANSFER RATE

Nanik Ram Parhyar\*, Madad Ali Shah\*, Mir Mohammad Lodro\*

## ABSTRACT

Power Line Communication (PLC) is a technology where existing power lines are being used for communication purposes along with transmitting electrical signals. There are two types of PLC communication i.e. Narrowband PLC, which is used for lower frequency ranges from 9 KHz to 140 KHz, and it provides data rates up to 1000 bit per second (bps) and the other type is Broadband PLC, which uses higher frequency ranges from 2 MHz to 30 MHz and it can provide significantly higher data rates i.e. more than 2 Mbps. The data transfer bound on power lines is due to the existing power signals which create Electromagnetic Interference (EMI) with communication signals, and the other factor is non-linearity of the power line itself. Moreover, because of its time-dispersive nature, it creates frequency-selective fading effect which may give rise to Inter-Symbol Interference (ISI). The purpose of this research is to know that how the power lines behave when high frequency signals are transmitted on it, with the help of mathematical modelling and graphs of transmitted signal. In this context, the power-line is approximated as a two-wire transmission line, through which behaviour of the signals transmitted on PLC channel can be analysed. From the mathematical modelling perspective, it has been contributed that the amplitude and phase of transmitted signals are functions of distance and frequency. These signals are more distorted and attenuated with increasing frequency and distance. Finally, with the help of simulation results, it can be demonstrated that PLC performance is better at 30MHz in comparison to 40 MHz. From the simulation results, it can also be observed that as the frequency increases, more the signal is being distorted and attenuated. Therefore signals with higher frequencies have huge losses and phase of the signals remain linear.

*Keywords: PLC, Characteristic Impedance, Propagation Constant and Multipath.*

## 1. INTRODUCTION

Power lines provide harsh environment for high frequency communication signals [1]. One of the prominent errors may be multipath effects, which is produced due to impedance mismatch on PLC channel. PLC channel also contains different types of noise i.e. impulse noise, background noise, narrowband noise, and also the attenuation of transmitted signals [2-3]. Therefore, it becomes necessary to model the PLC channel. There are two approaches through which PLC channel can be modelled, one is multipath model and the second is transmission line approach [4]. In this research, two-wire transmission line theory is adopted. Power line applications are enormous, few of them are mentioned here including achieving load management [5], remote controlled appliances, home automation, intelligent buildings, remote distance meter reading in smart grids etc. Nowadays, smart grids are replacing classic grids with increased power management. Smart grid deployment requires significant contribution from communication engineers. Therefore, in smart grids the

PLC is inevitable. Hence, in future high frequency signals will be transmitted over power lines. One of the biggest advantage of PLC is that the existing power line infrastructure may be used for both; the transmission of data and Power signals [5], and this ultimately saves the cost to avoid building a complete infrastructure. PLC modems are used to make communication in power supply networks. Data signals from conventional communication devices are converted by PLC modem in a form that is suitable for transmission over power lines [6].

These power transmission line systems are spread in a large geographical area and approximate power lines are spread to everyone's home, therefore these persons will be able to receive broadband services without rolling over completely new infrastructure that is significantly costly. In addition to numerous advantages associated with the power lines there are disadvantages in the form of behaviour of the power lines, as the power lines are designed to carry the power signals at 60Hz frequency. Therefore, the power lines impose serious challenges to

---

\* Department of Electrical Engineering, Sukkur Institute of Business Administration, Airport Road, Sukkur-65200, Sindh Pakistan.  
nanik.ram@iba-suk.edu.pk

the higher data transfer rates. The EMI and time depressiveness of the channel poses restriction on high data transfer rates. The power line communication can create ISI because of the frequency-selective fading nature, therefore requiring the need of advanced equalization techniques and contributing to complexity and cost. Fig. 2 shows approximated two-wire transmission line as tapped-delay line filter. As power line channel contains a lot of contaminations, recent work is carried on to mitigate these contaminations and to make the data transfer rates higher [1-2]. Moreover, Orthogonal Frequency Division Multiplexing (OFDM) can also be used to mitigate the ISI that may arise in power line communication channel. Since the PLC channel provides unfavourable environment for the telecommunication signals, it encodes the signal that is considered to be fundamental for data protection [7]. This manuscript is divided in various sections i.e. research methodology is presented in section 2, broadband PLC channel modelling is part of section 3 which includes detailed transmission line and filter transfer function approach. Section 4 contains the simulation results and discussions and finally conclusions and future recommendations are given in section 5 and 6 respectively.

## 2. RESEARCH METHODOLOGY

Different research papers [1-10] were investigated thoroughly in order to get reasonable knowledge about PLC and sorted out what can be the research interest in the PLC. As a result it has been revealed that PLC channel causes huge distortion and attenuation to the signals which are transferred on PLC channel because of its nature. The power lines are made for transmitting energy signals whose frequency is much smaller than the communication signals. In order to transmit the higher frequency signals on the power line, it was necessary to study the PLC channel in detail. After rigorous research, it was revealed that there are two approaches of modelling the PLC channel i.e. multipath modelling and two-wire transmission line modelling [8], through which behaviour of the transmitted signals can be analysed. These approaches were scrutinized for requiring more information about the pros and cons of both techniques. By investigating it is known that Multipath approach is based on the reflections of signals from different branches because of impedance mismatching [9]. The multipath nature of power lines arise from the presence of several branches and impedance mismatch that causes the reflection of the signals [4]. This approach has two main disadvantages first is that because it becomes difficult to estimate delay, amplitude and phase associated with each path, it requires complex computations [10]. Secondly, it is a time domain approach, as all the paths from which reflections have occurred are taken into account and these paths complex in numbers, so this approach becomes

complicated. However, multipath modelling can easily be applied for wireless channels. So depending on advantages and simplicity, two-wire transmission line has been selected to model PLC channel. By two wire transmission modelling, the behaviour of signals on power line communication channel can be analysed. During the research, it was also known that power lines have multipath effects. Finally, in this research, two-wire transmission line theory approach was adopted. As mathematical modelling was not enough to understand the behaviour of the signals completely therefore it was also necessary to show the graphical representation of behaviour of different signals. Hence some simulations were performed at various frequencies and the channel was considered as a two wire transmission line to show the true picture of signals. According to mathematical modelling, phase and magnitude response of the signals must also be simulated. For this purpose, the performance parameters which are magnitude response and phase response of signals, were simulated at different frequencies. It was again found that which software could help to show the magnitude and phase response of the transmitted signals at different signal considering channel as a two wire transmission line. It was also found that there is an RF tool box in MATLAB software in which parameters of two wire transmission line can be set and different responses like magnitude response and phase response can be simulated by setting different frequency ranges. Therefore the software that has been used for the simulation results is Math-work's MATLAB 7.0. In MATLAB the RF tool box helped to assess the performance parameters which are magnitude response and phase response. Those have been simulated at different frequencies by setting the parameters of two-wire transmission line channel.

## 3. MATHEMATICAL MODELLING

As there are two approaches of modelling PLC channel, depending upon some advantages as discussed above, the two wire transmission line approach is implemented in detail. In this approach, power transmission lines are modelled as two-wire transmission lines and by using scattering parameters the voltage and current at both input and output are related. Here two parameters i.e. propagation constant and intrinsic impedance are investigated. The intrinsic impedance of two-wire transmission line must stay constant to avoid impedance mismatch and reflections [8]. Through propagation constant which is imaginary number, the information is given about the phase shift constant and attenuation constant. By using two parameters i.e. intrinsic impedance and propagation constant, transfer function for PLC [11] or transmission matrices [12] can be obtained by using echo-based model. Equivalent circuit of two-wire transmission line is shown in Fig.1.

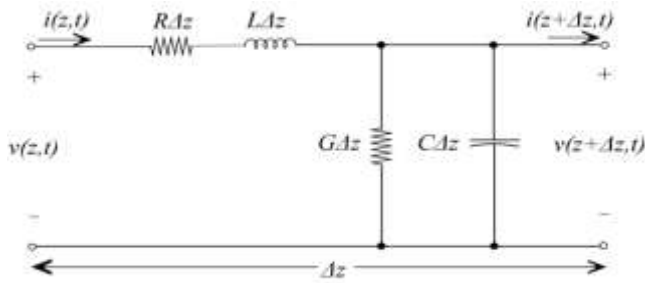

Figure-1. Equivalent circuit for two-wire transmission line

In Figure 1,  $i(z, t)$  and  $i(z + \Delta z, t)$  represent the currents at position  $z$  and  $z + \Delta z$  respectively, whereas  $v(z, t)$  and  $v(z + \Delta z, t)$  represent the voltages at position  $z$  and  $z + \Delta z$  respectively.  $R$  is series resistance per unit length ( $\Omega/m$ ) of the transmission line conductors;  $L$  is series inductance per unit length (H/m) of the transmission line conductors;  $G$  is shunt conductance per unit length (S/m) of transmission line conductors and  $C$  is shunt capacitance per unit length (F/m) of transmission line conductors.

By using the Kirchhoff's Voltage Law (KVL) and Kirchhoff's Current Law (KCL) equations, the values of voltage and current are calculated at  $z$  and  $z + \Delta z$ .

$$v(z, t) - R\Delta z i(z, t) - L\Delta z \frac{\partial i(z, t)}{\partial t} = v(z + \Delta z, t) \quad (1)$$

$$i(z, t) - G\Delta z v(z + \Delta z, t) - C\Delta z \frac{\partial v(z + \Delta z, t)}{\partial t} = i(z + \Delta z, t) \quad (2)$$

Taking the limit as  $\Delta z \rightarrow 0$ , the terms on the right hand side of equations above become partial derivatives with respect to  $z$  which gives

$$\frac{\partial v(z, t)}{\partial t} = -Ri(z, t) - L \frac{\partial i(z, t)}{\partial t} \quad (3)$$

$$\frac{\partial i(z, t)}{\partial t} = -Gv(z, t) - C \frac{\partial v(z, t)}{\partial t} \quad (4)$$

For time-harmonic signals, the instantaneous voltage and current may be defined in terms of phasor such that

$$v(z, t) = \text{Re}\{V(z)e^{j\omega t}\} \quad (5)$$

$$i(z, t) = \text{Re}\{I(z)e^{j\omega t}\} \quad (6)$$

The derivatives of the voltage and current with respect to time yields  $j\omega$  times the respective phasor which gives

$$\frac{dV(z)}{dz} = -[R + j\omega L]I(z) \quad (7)$$

$$\frac{dI(z)}{dz} = -[G + j\omega C]V(z) \quad (8)$$

Differentiating both equations (7) and (8), we get the current and voltage equations as follows

$$\frac{d^2V(z)}{dz^2} = -\gamma^2 V(z) \quad (9)$$

$$\frac{d^2I(z)}{dz^2} = -\gamma^2 I(z) \quad (10)$$

Equations (9) and (10) are called Telegrapher's equations which describe the voltage and current on transmission line with respect to distance and time. Where  $\gamma$  is the propagation constant of travelling wave on transmission line. Thus propagation constant of two-wire transmission line has been derived and is given below in equation (11), real part of propagation constant is attenuation constant and imaginary part is phase constant. Attenuation constant is defined as the rate at which amplitude of travelling wave is attenuated whereas phase constant is defined as the rate at which phase of travelling wave is changed:

$$\gamma = \alpha + j\beta = \sqrt{(R + j\omega L)(G + j\omega C)} \quad (11)$$

The general solutions to voltage and current of telegrapher's equation are given below:

$$v(z) = V_0^+ e^{-\gamma z} + V_0^- e^{\gamma z} \quad (12)$$

$$I(z) = I_0^+ e^{-\gamma z} + I_0^- e^{\gamma z} \quad (13)$$

In above equations superscript plus and minus indicate the travelling wave in  $+z$  and  $-z$  directions. By relating the general solutions with equations 7 and 8 we get:

$$\frac{V_0^+}{I_0^+} = \frac{V_0^-}{I_0^-} = \frac{R + j\omega L}{\gamma} \quad (14)$$

By replacing the  $\gamma$ , characteristic impedance can be found that is defined as the ratio of voltage to current of a travelling wave on the transmission line. Characteristic impedance expression as show in Equation (15) is obtained in the form of conductance, resistance, inductance and capacitance.

$$z_0 = \sqrt{\frac{R + j\omega L}{G + j\omega C}} \quad (15)$$

The Transmission line parameters have been determined by using two-way transmission line model for PLC channel considering the type of conductor which is used. Equation (16) represents the resistance ( $R$ ), conductance ( $G$ ), and Equation (17) represents inductance ( $L$ ) and capacitance ( $C$ ) of a transmission line per unit length have been determined on which characteristic impedance depends

$$R = 1 / \pi(\sqrt{\pi f \mu / \sigma}), G = \pi \sigma / (\cos^{-1}(D/2a)) \quad (16)$$

$$L = \mu / \pi(\cos^{-1}(D/2a)), C = \pi \epsilon / (\cos^{-1}(D/2a)) \quad (17)$$

### 3.1 TRANSFER FUNCTION

Whenever the signal is transmitted at the receiver end, it doesn't get one direct signal but get multiple signals with delayed versions. Because of impedance mismatching, the signals are reflected back and the PLC channel behaves like a multipath environment. Therefore the echo-model in Figure 2 is used to represent the different parameters of transmission line [8] and using this model, the transfer function of broadband PLC channel can be derived. The echo model shown in Figure 2 can be applied to model the PLC channel and the impulse response of the complete echo model is given in equation (18).

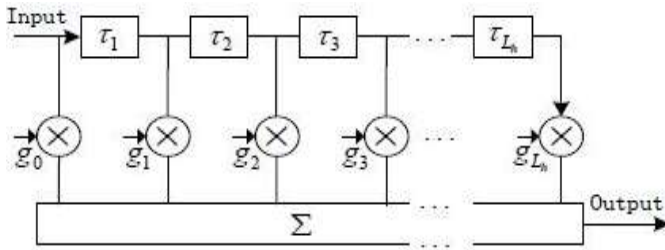

Figure-2. Echo Model of Power Line

$$h(t) = \sum_{i=1}^N g_i \delta(t - \tau_i) \quad (18)$$

Applying Fourier transform, the frequency response of echo model is shown in Equation (19):

$$H(f) = \sum_{i=1}^N g_i e^{-j\omega\tau_i} \quad (19)$$

In equations (18) and (19),  $g_i$  is the attenuation factor of path  $i$ .

## 4. RESULTS AND DISCUSSIONS

In order to strengthen the concept of mathematical modelling the magnitude response and phase response of transmitted signals are simulated. In this section the simulations of PLC channel are performed. In the MATLAB software there is an RF tool which is used for execution of simulations. In simulation, the channel is considered as a two-wire transmission line in which different plots of magnitude response and phase response are simulated on different frequencies and are analysed. The channel is simulated on two different frequencies i.e. 30MHz and 40MHz.

### 4.1 Magnitude Response at 30MHz

Magnitude response shows how the magnitude of a signal

behaves with respect to frequency when it is transmitted on a channel. For thorough understanding of magnitude response of a 30MHz signal two different scales are used i.e. linear scale and logarithmic scale.

#### 4.1.1 Linear Scale Magnitude Response

In linear scale magnitude response both the x-axis and y-axis are kept linear. Frequency is kept as parameter of horizontal x-axis whereas magnitude is kept as a parameter of vertical y-axis. Scale of frequency is given in MHz. Fig. 3 shows the amplitude response of a signal transmitted on the channel in linear scale at 30MHz. S11 and S22 are the scattering parameters which are also called as reflection coefficient, these are checked during simulations. From the Fig. 3, it can be evaluated that the signal which is transmitted on PLC channel is distortion less as per equation (20). It can also be observed from Fig. 3 that the losses increases when the frequency is increasing.

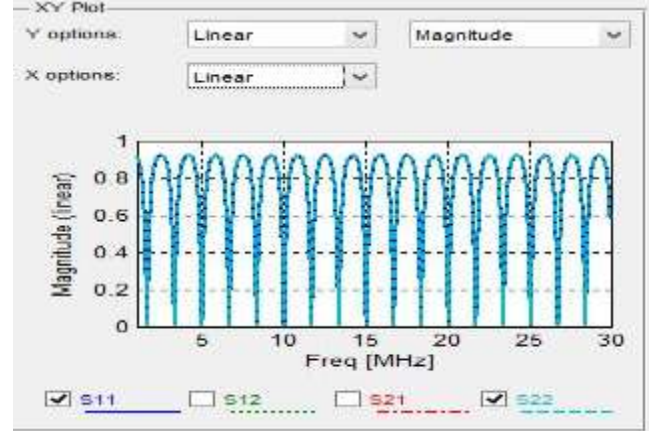

Figure-3 Magnitude Response of Linear Scale at 30MHz

Generally, it is expected that the transmission line should be distortion less within the required frequency [13]. A distortion less transmission line obtained can be modelled by following expression i.e. Equation (20).

$$H(\omega) = \begin{cases} ke^{-j\omega\tau_d} & \forall \omega \\ 0 & elsewhere \end{cases} \quad (20)$$

Similarly, the phase response of distortion less transmission line should be linear function of frequency over specified frequency.

#### 4.1.2 Logarithmic Scale Magnitude Response

In logarithmic scale magnitude response, the x-axis is kept at logarithmic scale whereas y-axis is kept as logarithmic (dB). Frequency is kept as parameter of horizontal x-axis whereas the magnitude is kept as a parameter of vertical y-axis. The scale of frequency is given in MHz. Fig. 4 shows the amplitude response of a



signal transmitted on the channel in logarithmic scale at 30MHz. S11 is the scattering parameter which is also called as reflection coefficient and is checked during simulations. In graph amplitude response is simulated according to S11 parameters. From the Fig. 4 it can be observed that at linear scale the signal which is transmitted on PLC channel is distortion less as per equation (20). It can also be perceived that there are dips at particular frequencies and the number of dips also increase as the frequency increases. These dips can cause the signal to be lost at particular frequency. These dips occur on PLC channel because of loads which are connected to the end terminals of power lines.

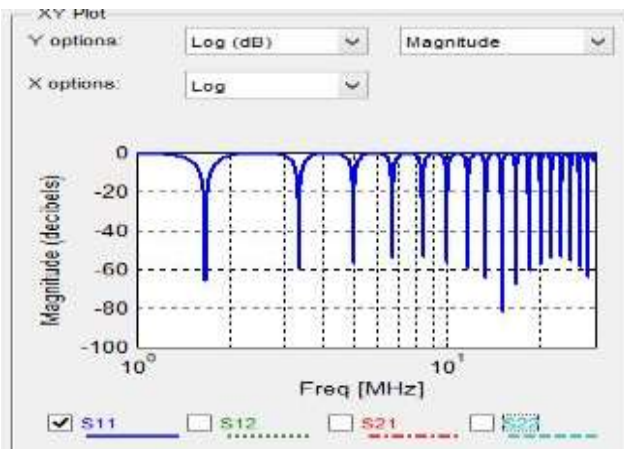

Figure-4 Magnitude Response of Logarithmic Scale at 30 MHz

#### 4.2 Phase Response at 30 MHz

Phase response shows how the phase of a signal behaves with respect to frequency when it is transmitted on a channel. Frequency is kept as parameter of horizontal x-axis whereas phase is kept as a parameter of vertical y-axis.

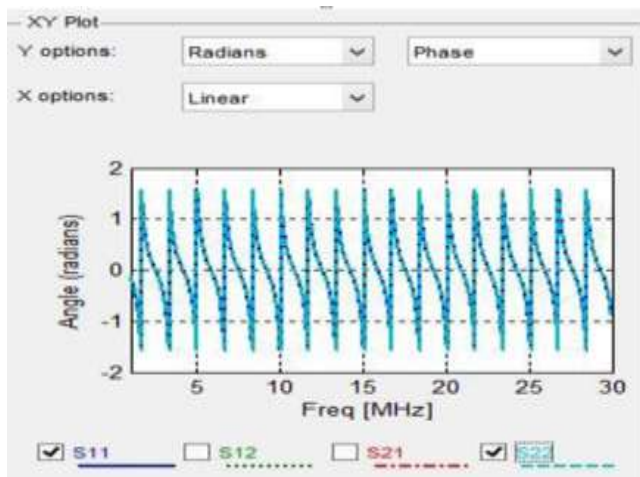

Figure-5 Phase Response at 30 MHz

axis. For the phase response of a signal, values on the x-axis are linearly related and the phase is measured in

radians on y-axis. Scale of frequency is given in MHz whereas phase in radians. Fig. 5 shows the phase response of a signal transmitted on the channel at 30MHz. S11 and S22 are the scattering parameters which are also called as reflection coefficients are checked during simulations. From the Fig. 5, it can be evaluated that the phase of the signal which is transmitted on PLC channel remains almost linear as the frequency increases. It can be said that phase of signal is not too much effected on PLC channel because the phase of the signal almost remains linear. Therefore the transmitted signals on PLC channel is distortion less as per equation (20).

#### 4.3 Magnitude Response at 40 MHz

In this section the magnitude response of a 40 MHz signal is analysed using two different scales i.e. linear scale and logarithmic scale.

##### 4.3.1 Linear Scale Magnitude Response

Here in linear scale, magnitude response of both the x-axis and y-axis are kept as linear. Frequency is kept as parameter of horizontal x-axis whereas magnitude is kept as a parameter of vertical y-axis. The scale of frequency is given in MHz. Fig. 6 shows the amplitude response of a signal transmitted on the channel in linear scale at 40MHz. S11 is one of the scattering parameters which is also called as reflection coefficient is checked during simulations. In graph amplitude response is simulated as per S11 parameters. From the Fig. 6, it can be evaluated that the signal, which is transmitted on PLC channel is more congested and have a severe distortion at 40 MHz scale. When magnitude response at 40 MHz is compared with the magnitude response of 30 MHz, signal having higher frequency, is more affected in the terms of distortion. The magnitude response of 40MHz also contain huge losses due to of the more dips which are less in the magnitude response of 30 MHz signals.

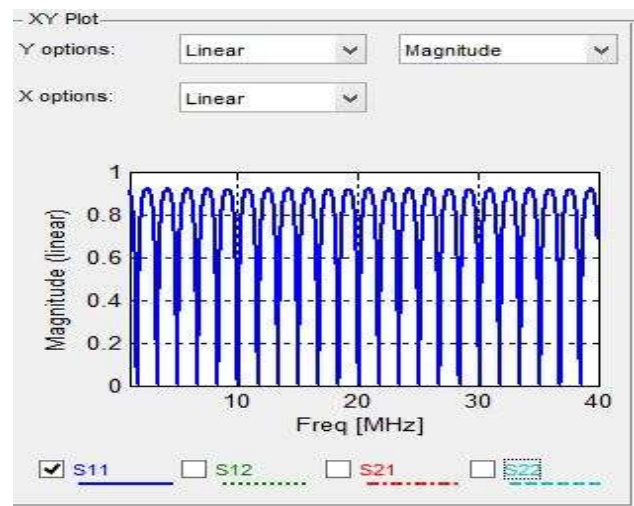

Figure-6 Magnitude Response of Linear Scale at 40 MHz

### 4.3.2 Logarithmic Scale Magnitude Response

In logarithmic scale the magnitude response x-axis is kept as logarithmic whereas y-axis is kept logarithmic (dB). Frequency is kept as parameter of horizontal x-axis whereas magnitude is kept as a parameter of vertical y-axis. Scale of frequency is given in MHz. Fig. 4 shows the amplitude response of a 40 MHz signal transmitted on the channel in logarithmic scale. S11 is the scattering parameter which is also called as reflection coefficient and is checked during simulations. In graph, amplitude response is simulated as per at S11 parameter. From the Fig. 7, it can be seen that there are huge dips in the magnitude response when 40 MHz signal is transmitted which causes the signals to be lost at particular frequencies. When magnitude response of 40 MHz signal is compared with the magnitude response of 30 MHz, the losses are higher in the magnitude response of 40 MHz signal. So it can be evaluated that signal having higher frequency are more affected by the loads, which are connected to the end terminals of power lines to incorporate more losses to the signals.

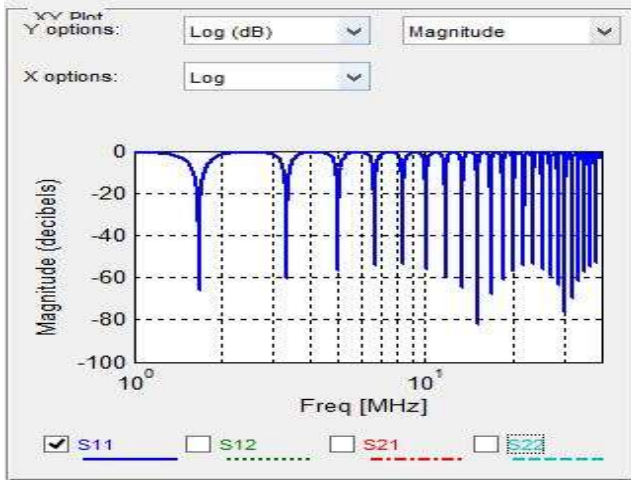

Figure-7 Magnitude Response of Logarithmic Scale at 40 MHz

### 4.4 Phase Response At 40 MHz

Phase response shows how the phase of a signal behaves with respect to frequency, when it is transmitted on a channel. Frequency is kept as parameter of horizontal x-axis whereas phase is kept as a parameter of vertical y-axis. For the phase response of a signal, values on the x-axis are linearly related and the phase is measured in radians on y-axis. Scale of frequency is given in MHz whereas phase is given in radians. Fig. 8 shows the phase response of a signal transmitted on the channel at 30MHz. S11 is the scattering parameter which is also called as reflection coefficient and is checked during simulations. In Fig. 8 it is shown that the phase response of a 40 MHz signal also remains linear when it is transmitted on the PLC channel. It can be said that the phase of signal is not

too much affected on PLC channel at 40MHz because the phase of the signal almost remains linear. So it can be evaluated that the phase response of signals at 30MHz and 40 MHz remain same and it is not much affected by PLC channel.

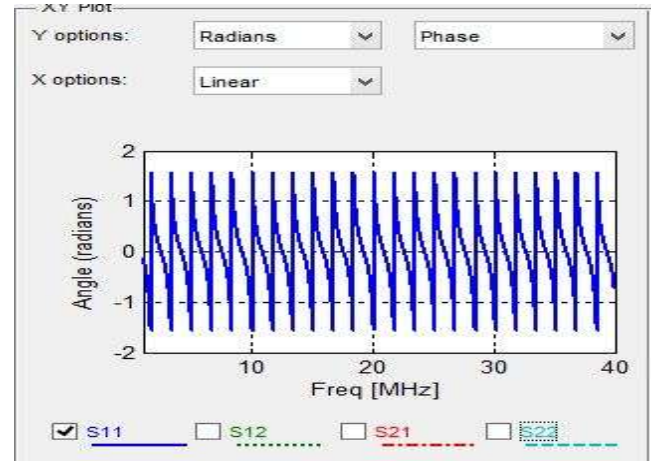

Figure-8 Phase Response at 40 MHz

## 5. CONCLUSIONS

In this research, PLC channel has been modelled as a two-wire transmission line channel. With the help of it, behaviour of the transmitted signals can be analysed in terms of voltage and current. It has been shown that the phase and magnitude of the transmitted signals depend on frequency and distance. It has also been stated that as frequency and distance increase more, the signals are more attenuated and distorted. So, it can be concluded that magnitude and phase response of the transmitted signals are functions of frequency and distance. Two parameters i.e. characteristic impedance and propagation constant have also been derived, which also contributes to the phase response and magnitude response of transmitted signal. By using echo-based model, the transfer function of PLC channel has been modelled, from which it can be observed that PLC channel contains multipath environment. After that in order to further strengthen the mathematical modelling concept, some simulations have been performed on MATLAB. Two different types of plots including magnitude response and phase response at 30MHz and 40MHz have also been illustrated. These simulation results showed that signals having higher frequency (i.e. 40 MHz) in comparison to the lower frequency (i.e. 30 MHz) are more attenuated in magnitude, however phase response of both the signals somehow remains linear.

## 6. FUTURE RECOMMENDATIONS

The PLC is envisioned as a platform for various Smart Grid (SG) applications [14], in which applications like automatic meter reading from remote distance and remote

controlling of load can be used and it is also considered for high-data transfer rate. The management of the SG is based on command and control services that require robust, low-data-rate communications [15]. Therefore, advance receiver design techniques from wireless or wired communication should be adapted given the constraints of PLC and channel capacity bound may also be investigated. PLC can be used to enable vehicular communications and networking. The research is also going on in order to incorporate PLC technology in electric vehicles for making less use of electric wires in vehicular systems [16]. PLC can efficiently be used in application of home networking scenarios [17].

## REFERENCES

- [1] Tang L.T., So P.L., Gunawan E., Chen S., Lie T. T., Guan Y.L., "Characterization of In-House Power Distribution Lines for High Speed Data Transmission", Conference of Fifth International Power Engineering Conference (IPEC2001), Vol. 1, pp.7-12, Singapore, May 2001.
- [2] Tanaka M., "High frequency noise power spectrum, impedance and transmission loss of power line in Japan on intra-building power line communications", journal of IEEE Transactions on Consumer Electronics, Volume 34, No.2, pp.321-326, 2002.
- [3] H. Philipps, "Development of a Statistical Model for Power line Communication Channels", Proceeding 4<sup>th</sup> International Symposium on Power Line Communications and its Applications, Ireland, April 2000.
- [4] Bo Tan and Tompson John, "Powerline Communications Channel Modelling Methodology Based on Statistical Features.", arXiv preprint arXiv:1203.3879, 2012.
- [5] Ferriara HC, Grove HM, Hooei jen O and Wink AJ Hank, "Power Line Communication (Overview)", Conference of IEEE AFRICON 4<sup>th</sup>, Volume 2, pp.558-563, September 1996
- [6] Mannan Abdul, Saxena D.K. and Banday Mahroosh, "A Study on Power Line Communication", Journal of International Journal of Scientific and Research Publications, Volume 4, No. 7, July 2014
- [7] Andrea dou Nikoleta and Tonello M. Andrea, "On the Mitigation of Impulsive Noise in Power-Line Communications With LT Codes", Journal of IEEE transactions on power delivery, Volume 28, No. 3, pp.1483-1490, July 2013
- [8] Meng H, Chen S, Guan Y.L, "A Transmission line Model for High Frequency Power line Communication Channel", International conference on Power System Technology Proceedings IEEE, Volume 2, pp.1290-1295, October 2002
- [9] Thomas Mini. S., Chandna Kumar, Vinayand Arora Seema, "Load Modelling of Broadband Power line Communication Channel (BPLC) Network", International Journal of Advanced Research in Electrical, Electronics and Instrumentation Engineering, Volume 2, Special Issue 1, December 2013
- [10] Meng H, Chen S, Guan Y.L, "Modelling of Transfer Characteristic of Broadband Power Line Communication Channel", Journal of Power Delivery, IEEE Transactions on Volume 19, No. 3, pp. 1057-1064, July 2004
- [11] Sartenear T., Delogne P., "Power Cables Modelling for Broadband Communications", Proceeding International Symposium Power Line Communication and Its Applications, Ireland, April 2001
- [12] Banwell T.C., Galli S., "A New Approach to the Modelling of the Transfer Functions of Power Line Channel", proceeding International Symposium on Power Line Communications and Its Applications, Ireland, April 2001
- [13] Chen Hongyu, Shi Rui, Cheng Chung-Kuan, "Surfliner: a distortionless electrical signaling scheme for speed of light on-chip communications" published in Computer Design: VLSI in Computers and Processors, 2005. ICCD 2005. Proceedings. 2005 IEEE International Conference on, vol., no., pp.497-502, 2-5 Oct. 2005
- [14] M. Nassar, Lin Jing, Y. Mortazavi, A. Dabak, Kim Han Il, B.L Evans, "Local Utility Powerline Communications in the 3-500kHz Band: Channel impairments, Noise and Standards", Journal of Signal Processing Magazine, IEEE, Volume 29, No. 5, pp. 116-127, 2012
- [15] Tonello M. Andrea, Versolatto Fabio, and Gritto Mauro, "Multi-technology (I-UWB and OFDM) Coexistent Communications on the Power Delivery Network", Journal of IEEE transactions on power delivery, Volume 28, No. 4, pp. 2039-2047, October 2013
- [16] Nouvel Fabienne, Tanguy Philippe, "In Vehicle Communication Networks: A Power line communication Study and Demonstrator for Infotainment Applications", Conference of ICSNC, the Ninth International Conference on Systems and Networks Communications in France, 2014
- [17] Antoniali Massimo and Tonello M. Andrea, Senior Member, IEE, "Measurement and Characterization of Load Impedances in Home Power Line Grids", Journal of IEEE transactions on instrumentation and measurement Volume 63, No.3, pp.548-556, October 2013

# ANTIOXIDANT ACTIVITY AND TOTAL PHENOLICS CONTENT OF EXTRACTS FROM MURRAYA KOENIGII (CURRY LEAVES), LAURUS NOBILIS (BAY LEAVES), AND CAMELLIA SINENSIS (TEA)

Shagufta Ishtiaque\*, Shahina Naz\*\*, Noorullah Soomro\*\*\*, Kehkashan Khan\*\*\*\*, Rahmanullah Siddiqui\*\*\*\*\*

## ABSTRACT

Antioxidant potential is related to polyphenolics content, the focus of present study was to estimate and evaluate total phenolics content (TPC) and antioxidant activity (AOA) of the cost-effective natural sources. For this purpose, leaves from three plant species including *Murraya koenigii* (curry leaves), *Laurus nobilis* (bay leaves), and *Camellia sinensis* (green and black tea leaves) were selected and analyzed. The AOA was determined using 2,2-diphenyl-1-picrylhydrazyl (DPPH) assay, Ferric reducing antioxidant power (FRAP) assay and iron(II) chelating activity (ICA). Methanol was used for the extraction of polyphenols from leaves. Results showed that the highest TPC (15300 mg GAE /100g) and the highest AOA (DPPH = 51 to 88%; FRAP = 24-85%; and ICA=19-74%) was found in the green tea leaves. The lowest TPC (170 mg GAE /100g) and the lowest AOA (DPPH = 20-64%; FRAP = 18-48%; and ICA=15-42%) were shown in curry leaves. Antioxidant activities were analyzed at different concentration ranges (50-250µg/100µl) and the result showed that AOA was concentration dependent. These leaves extract may be exploitable not only as a health supplementary, nutraceuticals values but also in the food preservation and packaging materials.

**Key words:** TPC, DPPH, FRAP, AOA, chelating, green/black tea, curry leaf, bay leaf.

## 1. INTRODUCTION

Plant extracts are rich source of natural antioxidants and are being used as therapeutic agents [1], [2], nutraceuticals [3], and food preservatives [4]. One of the goals of natural product plant based research is to identify such phytochemicals whose potential novel action against deadly diseases can be unveiled. The naturally occurring antioxidants also used to replace synthetic ones. The side effects of synthetic antioxidant, for example, Butylated hydroxyanisole (BHA) and Butylated hydroxytoluene (BHT) are well known [5].

To stay healthy, human body needs well developed immune system with better resistant adaptability to fight against deadly bacteria and viruses. In this context, role played by balanced diet with important nutrients cannot be ignored. To evaluate antioxidant potential, different biological assays have been developed and are being used effectively. Similarly, various bioactive constituents present in the food, responsible for antioxidant activity, have also been identified from a number of plant species. Many fruits and vegetables have been screened for their antioxidant potential and total phenolics content. With the growing need of food nutraceuticals to fight against deadly diseases another challenge for researchers to meet with is to unveil cost-effective natural product antioxidant sources. Based on these facts, *Murraya Koenigii*, *Laurus nobilis*, and *Camellia sinensis* leaves were selected for the present study and their total phenolics content and antioxidant activity was evaluated.

During various metabolic activities, certain reactive oxygen species (ROS) produced in human body, are the root cause of different diseases, for instance, atherosclerosis, rheumatoid arthritis, cancer, etc. The damage caused by these free radical species is checked by various enzymes (catalase, superoxide dismutase, etc.) or compounds (phenolics, tocopherols, etc.) present in the body [6]. Antioxidant potential of phenolic compounds is a scientifically established reality now [7]. Based on these facts, edible plants are being screened for their naturally occurring antioxidant constituents. Pakistan's fertile land and better adapted canal system is the habitat of more or less 800 different plant species. It is reported that more than 90 nutritionally and medicinally important edible fruits in Pakistan are not consumed well. Edible fruits and vegetables are amongst the major sources of polyphenols. These polyphenolics attribute better quality (shelf life, taste, appearance) and therapeutic importance to food. In other words, these reduce oxidation reactions in food substances [8]. Hence, the objective of current study is to estimate polyphenolics content and evaluate antioxidant potential of some of these underutilized and economical plant species including *Murraya koenigii* (Curry leaf), *Laurus nobilis* (Bay Leaves), and *Camellia sinensis* (Tea).

*M. koenigii* is a well known leafy spice and used as a preservative in Asian-Indian cuisine. The smaller quantity of *M. koenigii* is sufficient to use due to its distinct aroma [9]. Besides reported dietary importance, medicinal potential of *M. koenigii* has also been established [10].

\* Department of Chemical Engineering, University of Karachi, Karachi 75270, Pakistan

\*\* Department of Chemistry, University of Karachi, Karachi 75270, Pakistan

\*\*\* Textile Engineering Department, Mehran Engineering University, Jamshoro, Pakistan

\*\*\*\* Department of Food Science & Technology, University of Karachi, Karachi 75270, Pakistan

Another important plant species used in the current study was *Laurus nobilis* (Bay Leaves). It is also used in cooking due to its peculiar flavor and fragrance in either fresh or dried form. Isolated compounds from *L. nobilis* have already been evaluated for their antioxidant potential [11]. It is cultivated in hilly areas of Pakistan.

Medicinally, *L. nobilis* is reported for the treatment of epilepsy, Parkinsonism, diabetes, etc. It is also a well known plant in Mediterranean cuisines. Preventive or therapeutic role of polyphenolics content of *Camellia sinensis*, (utilized as black, green or oolong tea) against several diseases is also reported [12]. Moreover, its antioxidant activity has also been evaluated earlier [13].

## 2. MATERIALS AND METHODS

### 2.1 Sample Preparation

Packets of (1 kg) Green, black tea (*C. sinensis*) and Bay leaves (*L. nobilis*) were purchased from the departmental store of Karachi, Pakistan. The curry leaves (*M. koenigii*) was picked from the garden at the University of Karachi in July 2014. After washing with water and air drying in open sieves, the leaves were stored at  $-5^{\circ}\text{C}$ . All the solvents and chemicals used were of analytical grades and supplied by either Merck or BDH.

### 2.2 Extraction of Polyphenols From Leaves

Previously reported procedure was followed for the extraction of polyphenols from the crude methanol extract [14]. The sample size of all types of leaves were about 500g.

### 2.3 Determination of Total Phenolics

Total phenolics content was estimated in all four leaves extract following the procedure used by Jayaprakasha et al. [15] with slight modification as reported earlier [16]. Firstly 2 ml mixture of methanol and water (8:6) was prepared to dissolve the sample (12mg). After that 4 ml of (1:10 diluted) Folin-Cicolteu reagent was added in the solution with 4 ml of 10% sodium carbonate solution. The whole content (prepared mixture) was kept at  $30^{\circ}\text{C}$  for 40 minutes then absorbance was measured at 567nm using Spectrophotometer (UV VIS Shimadzu). Gallic acid (GA) was used as a standard curve and result were presented in mg GAE/100g.

### 2.4 Antioxidant Activity

Three different protocols were followed for the determination of antioxidant activity of crude methanol extracts including DPPH, FRAP, and ICA.

### 2.4 Radical Scavenging Using DPPH Assay

The protocol developed earlier was used for the evaluation of DPPH scavenging potential with minor variations [17]. Different concentration samples (50-250

mg/100  $\mu\text{l}$ ) were prepared in methanol. The samples prepared were treated with 1.4 ml DPPH solution in methanol (0.2 mM) and 1.5 ml distilled water. After vigorous mixing the resultant mixture was placed in dark place for the interval of 30 minutes. Decreased absorbance of the samples was observed against blank at 515 nm using Spectrophotometer (UV-270 Shimadzu).

### 2.5 Ferric Reducing-Antioxidant Power (Frap)

This is based on the reduction power of all types of leaves extract from  $\text{Fe}^{+3}$  to  $\text{Fe}^{+2}$ . Previously reported protocol by Jayaprakasha et al. [15] for the estimation of ferric reducing power was followed.

Different concentration of samples were prepared in methanol (50-250  $\mu\text{g}/\text{ml}$ ) and 2.5 ml of both; phosphate buffer (0.2 M, pH 6.6) and 1% potassium ferric cyanide were added. It was then followed by incubation of the samples prepared (for 20 minutes, maintained at a temperature of  $50^{\circ}\text{C}$ ). To this incubated mixture, 2.5 ml 10% trichloroacetic acid was added and the resulting mixture was centrifuged at 5000 rpm for 10 minutes. After adding 2.5 ml double distilled water and 0.5 ml 0.1 %  $\text{FeCl}_3$  to the supernatant (2.5 ml), absorbance was measured at 595 nm. Reducing power was evaluated by increased absorbance of the samples in triplicate.

### 2.6 Chelating Effect

Chelating effect of the samples was evaluated using 2, 2-bipyridyl assay [18]. Methanol was used to prepare varying concentration of leaves samples (50-250  $\mu\text{g}/\text{ml}$ ). To 0.25 ml samples, 0.25 ml of 1mM  $\text{FeSO}_4$  solution, 1 ml tris-HCl buffer (pH 7.4), 0.1% of 1ml 2,2 $\mu$ -bipyridyl solution prepared in 0.2M HCl and 2.5 ml methanol were added.  $\text{Fe}^{2+}$  chelating activity of the samples was determined by measuring absorbance at 563 nm using standard Ethylene di-amine- tetra acetic Acid ( $\text{Na}_2\text{EDTA}$ ) using Spectrophotometer (UV VIS Shimadzu)

### 2.7 Statistical Analysis

Statistical analysis was performed using samples in triplicates. Mean  $\pm$  standard deviation was used to express data. Applying Pearson correlation test, relationship between antioxidant activity and total phenolics content was calculated. With the help of tukeys' test and analysis of variance (ANOVA) significant differences (at  $p < 0.05$ ) among the mean values were found.

## 3. RESULTS AND DISCUSSION

Studies of natural phenolics compounds have received more attention in the past few years because of its antioxidant properties. These antioxidant phenolics compounds reduce the toxic effect of reactive oxygen intermediates (ROI) generated by normal cellular metabolism in our body. Results of this study showed that

TPC was the highest (15300 mg GAE /100 g) in green tea followed by the black tea (12500 mgGAE /100 g), Bay

leaves (550 mg GAE/100 g) and the lowest (170 mg/100 g) in curry leave (table 1).

Table 1: Total Phenols and antioxidant activity of *C. sinensis* (black), *C. sinensis* (green), *M. koenigii* and *L. nobilis* leaves. (p< 0.05) all values in mean (n=3).

Samples µg/100µl	Total Phenols mg/100g	Antioxidant Activity		
		%DPPH Scavenging	% Ferric Reducing	% Chelating Effect
<i>C. sinensis</i> (black) 50 100 150 200 250	12500	63±1.55 67±1.23 74±3.20 83±1.60 88±2.01	55±1.09 60±2.08 66±1.56 76±2.10 80±2.78	51±2.09 55±2.08 60±2.56 64±2.10 69±1.78
<i>C. sinensis</i> (green) 50 100 150 200 250	15300	75±2.30 82±1.90 87±1.67 92±1.20 95±2.06	61±1.89 69±2.30 74±1.52 80±0.51 85±2.01	56±2.09 61±2.08 66±2.56 70±2.10 74±1.78
<i>M. koenigii</i> 50 100 150 200 250	170	20±0.51 29±2.30 37±2.08 47±0.51 54±2.08	18±0.50 25±2.00 33±2.00 40±0.45 48±2.00	15±0.56 20±2.35 30±2.88 36±0.88 42±2.00
<i>L. nobilis</i> 50 100 150 200 250	550	30±2.08 41±0.51 49±1.78 58±2.08 65±0.51	24±2.00 33±0.50 42±1.00 53±2.00 60±0.55	19±2.00 26±0.50 35±1.00 46±2.00 53±0.50

A previous study by Anesini et al. reported the total phenolics concentration 21.0 to 14.3 and 17.6 to 8.4 % of gallic acid equivalents (GAE) for green and black tea, respectively [19]. Other studies reported 27.1 to 25.7 and 22.3 to 17.5% GAE for green and black tea respectively [5]. Our findings are in similar range for green and black tea( 15300 mg GAE /100 g and 12500 mg GAE /100 g) with the values reported. The minor variation in results may accounts for the natural parameters involved, including genetic composition and cultivar or variety difference. Other responsible factors include release of polyphenol oxidize during cutting or rolling of tea shoots. This enzyme interacts with polyphenolics content and reduces its concentration [5]. Besides above discussed factors, different quantification and extraction procedures adapted, can also contribute in the difference of

polyphenolics content [20].

With some exceptions, previous studies reported that total phenolics content extracted better in methanol compared to ethanol and water. This is because methanol inhibits polyphenol oxidase which is responsible for the oxidation of phenolics content and its reduced amount. Another reason for choosing methanol over ethanol and water is its ability to evaporate easily[21].

The results of this study showed that *C. sinensis* (green) exhibited the highest antioxidant potential whereas *M. koenigii* showed the lowest (*C. sinensis* (green) > (black) > *L. nobilis* > *M. koenigii*). The numerical values obtained for *C. sinensis* (green and black), *L. nobilis*, and *M. koenigii* were < 20mg/100 µl, 20-30 µg/100 µl, 150 mg/100 µl (Fig. 1 and Table 1) respectively.



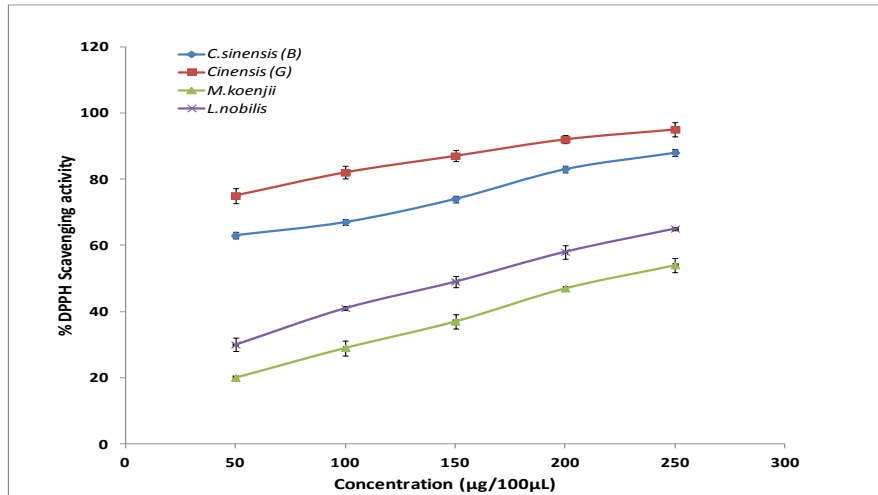

Figure 1: % DPPH scavenging activity of the crude Polyphenolic extracts derived from *C. sinensis* (black), *C. sinensis* (green), *M. koenigii* and *L. nobilis* leaves.

The antioxidant potential of green tea has been estimated to be higher as compared to black tea [19].

Among the all types of herbal leaves tested, the highest DPPH activity was shown by *C. sinensis* –green (green tea), *C. sinensis*-black (black tea) > *L. nobilis* > *M. koenigii*. The  $IC_{50}$  values for them < 20 µg/100µL, 20-30 µg/100µL, ~ 150 µg/100µL and 200-250 µg/100µL respectively. The  $IC_{50}$  value reported previously for *L. nobilis* (90 µg/100µL), was found to be much lower [22] compared to this study. Similarly antioxidant activity for *M. koenigii* leaf was found to be 116 µg/100µL [23] while some other studies on *M. koenigii* estimated the value of  $IC_{50}$  to be 0.006 mg/100µL, [24] which was

lower compare to our experimental values (table 1). Like DPPH, % FRAP and % chelating effect followed the same pattern and same order of effect among all four types of herbal leaves. A strong correlation was observed between the concentration and antioxidant activity

As mentioned previously the most probable reasons for these variations in the values may be due to the fact that phenolic compounds may be water-soluble, lipid soluble, insoluble, or bound to cell walls. Therefore the efficiency in extraction is very important factor in quantitative analysis of AOA of food samples besides the natural occurring causes of the variation

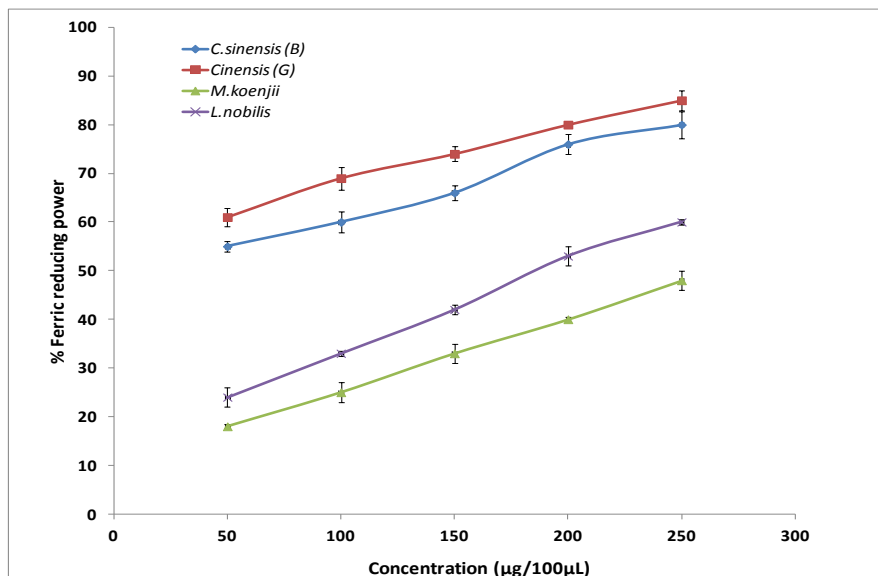

Figure 2: % Ferric reducing power of the crude Polyphenolic extracts derived from *C. sinensis*(black), *C. sinensis*(green), *M. koenigii* and *L. nobilis* leaves,  $p < 0.05$  and all values in triplicate (n=3)

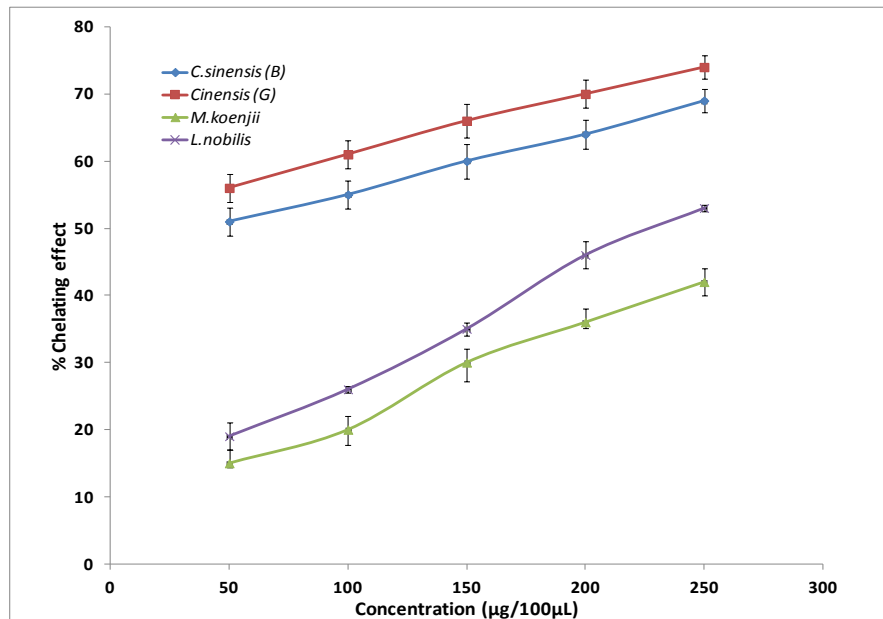

Figure 3: % Chelating power of the crude polyphenolic extracts derived from *C. sinensis*(black), *C. sinensis*(green), *M. koenigi*and *L. nobilis* leaves,all values in triplicate n=3(p<0.05)

#### 4. CONCLUSION

Among the three tested species; *M. koenigi*, *L. nobilis*, and *C. sinensis* (green and black leaves), the total phenolics content was found highest for *C. sinensis*-green (15300 mg GAE /100 g). All three methods used for determining the AOA showed increase in AOA with increase in the concentration of methanol extract. Our result indicated great scavenging activity of the leaves tested against reactive oxygen species (ROS). These plants may be good source of natural antioxidants. The results obtained from this study can be utilized in food, pharmaceutical and packaging industries. Food scientist and technologist are still working on exploration of more stable and economical resources of polyphenols.

#### 5. ACKNOWLEDGEMENTS

The corresponding author gratefully acknowledges University of Karachi for providing financial support for the present study through Karachi University Scholarship Fund for Ph.D. and Dean's Research Grant, Faculty of Science, University of Karachi.

#### 6. CONFLICT OF INTEREST

No conflicts of interest were found during the preparation of this manuscript.

#### REFERENCES

[1] Tamokou, J.D., Chouna, J.R., Fischer-Fodor, E., Chereches, G., and Barbos, O., "Anticancer and antimicrobial activities of some antioxidant-rich cameroonian medicinal plants", Plos One, Volume 8, No. 2, pp. 1-14, Romania, 2013.

[2] Saafi-Ben Salah, E.B., El Arem, A., Louedi, M., Saudi, M., Elfeki, A., Zakhama, A., Najjar, M.F., Hammami, M., and Achour, L., "Antioxidant-Rich Date Palm Fruit Extract inhibits Oxidative Stress and Nephrotoxicity Induced by Dimethoate in Rat" Journal of Physiology and Biochemistry, Volume 68, pp. 47-58, Tunisia, 2012.

[3] Srivastava, A., Shereen, R.H., and Shivanandappa, T., "Antioxidant activity of the roots of *Decalepis hamiltonii* (Wight & Arn.)", LWT-Food Science and Technology, Volume 39, No. 10, pp. 1059-1065, India, 2006.

[4] Preethi, R., Devanathan, V.V., and Loganathan, M., "Antimicrobial and antioxidant efficacy of some medicinal plants against food borne pathogens", Advances in Biological Research, Volume 4, No. 2, pp. 122-125, India, 2010.

[5] Kahl, R., and Kappus, H., "Toxicology of the synthetic antioxidants BHA and BHT in comparison with the natural antioxidant vitamin E", Zeitschrift fuer Lebensmittel-Untersuchung und-Forschung, Volume 196, No. 4, pp. 329-338, Deutschland, 1993.

[6] Sharma P, Jha Ab, Dubey RS, and Pessarakli M, "Reactive Oxygen Species, Oxidative Damage, and Antioxidative Defense Mechanism in Plants under Stressful Conditions", Journal of Botany, vol. 2012, pp. 1-26, 2012

[7] Bhuyan, L.P., Sabhapondit, S., Baruah, B. D., Bordoloi, C., Gogoi, R., and Bhattacharyya, P., "Polyphenolic compounds and antioxidant activity of CTC black tea of North-East India", Food Chemistry, Volume, 141, No. 4, pp. 3744-3751, India, 2013.

- [8] Diane M, Barrett, Beaulieu J C, And Shewfelt R, "Color, Flavor, Texture, and Nutritional Quality of Fresh-Cut Fruits and Vegetables: Desirable Levels, Instrumental and Sensory Measurement, and the Effects of Processing", *Critical Reviews in Food Science and Nutrition*, Vol.50, Pp.369–389, 2010.
- [9] Das, A.K., Rajkumar, V., and Dwivedi, D.K., "Antioxidant effect of curry leaf (*Murraya Koenigii*) powder on quality of ground and cooked goat meat", *International Food Research Journal*, Volume 18, pp. 563–569, India, 2011.
- [10] Handral HK, Pandith A, and Shruthi SD, "A review on *Murrayakoenigii*: Multipotential medicinal plant", *Asian Journal of Pharmaceutical and Clinical Research*, Vol. 5, Suppl. 4, pp. 5-14, India, 2012.
- [11] Vardapetyan, H., Tiraatsuyan, S., Hovhannisyanyan, A., Rukhkyan, M., Hovhannisyanyan, D., "Phytochemical Composition and Biological activity of *Laurusnobilis* L. Leaves collected from two regions of South Caucasus", *Journal of Experimental Biology and Agricultural Sciences*, Volume 1, No. 2, pp. 45-51, Armenia, 2013.
- [12] Ercisli E, Orhan E, Ozdemir O, Sengul M., and Gungor N, Seasonal Variation of Total Phenolic, Antioxidant Activity, Plant Nutritional Elements, and Fatty Acids in Tea Leaves (*Camelliasinensis* var. *sinensis* clone *Derepazari* 7) Grown in Turkey, *Pharmaceutical Biology*, Vol. 46, pp. 683–687, 2008.
- [13] Hara, Y., Luo, S.J., Wickremashinghe, R.L., and Yamanishi, T., "VI. Biochemistry of processing black tea", *Food Reviews International*, Volume 11, No. 3, pp. 457-471, 1995.
- [14] Kim, H., D.O and Lee, C.Y., "Extraction and Isolation of Polyphenolics", Unit 11.2, *Current Protocols in Food Analytical Chemistry*. John Wiley & Sons Inc, 2013
- [15] Jayaprakasha, G.K., Tamil, S.A., and Sakariah, K.K., "Antimicrobial and antioxidant activities of grape (*Vitisvinifera*) seed extract", *Food Research International*, Volume 36, No. 2, pp. 117-122, India, 2003.
- [16] Siddiqui, R., Naz, S., Saeed, S.M.G., Sayyed, S.A., Antioxidant activity of the extracts from *Terminalia Catappa*, *Pakistan Journal of scientific and Industrial journal*, 54, 2, 93-98.
- [17] Negi, P.S., Jayaprakasha, G.K. Antioxidant and antibacterial activities of *Punicagranatum* peel extract. *Journal of F. Sci.*, 68, 1473-1477, 2003
- [18] Re, R., Pellegrini, N., Proteggente, A., Pannala, A., Yang, M., Rice-Evans, C.A. (1999). Antioxidant activity applying an improved ABTS radical cation decolorization assay. *Free Radical Biology and Medicine*, 26, 1231–1237, 1999.
- [19] Anesini, C., Ferraro, G.E., and Filip, R., "Total polyphenol content and antioxidant capacity of commercially available tea (*Camellia sinensis*) in Argentina", *Journal of Food and Agricultural Chemistry*, Volume 56, No. 19, pp. 9225–9229, Argentina, 2008.
- [20] Marques, M. R., Paz, D. D., Batista, L. P. R., Barbosa, C. d. O., Araújo, M. A. M., and Moreira-Araújo, R. S. d. R.. An in vitro analysis of the total phenolic content, antioxidant power, physical, physicochemical, and chemical composition of *Terminalia Catappa* Linn fruits. *Ciênc Tecnol Aliment*, Vol 32, pp.209-13, 2012.
- [21] Pérez, M.B., Calderón, N.L., and Croci, C.A., "Radiation-induced enhancement of antioxidant activity in extracts of rosemary (*Rosmarinus officinalis* L.)", *Food Chemistry*, Volume 104, pp. 585-592, Argentina, 2007.
- [22] Srivastava, A., Tembhurne, S.V., and Sakarkar, D.M., "Hypoglycemic effects of fruit juice of *Murraya koenigii* (L) in alloxan induced diabetic mice", *International Journal of Pharm Tech Research*, Volume 1, No. 4, pp. 1589–1593, India, 2009.
- [23] Rani, U., Verma, R.N., and Batra, A., "Total phenolic (flavonoids) contents and antioxidants capacity of different *Murrayakoenigii*(L). Spreng, extracts", *International Journal of Medicinal plant Research*, Volume 1, No. 7, pp. 124-128, India, 2012.
- [24] Azlim, A.A., Ahmed, J.K.C., Syed, Z.I., Mustapha S.K., Aisyah, M.R., and Kamarul R.K. "Total phenolic content and primary antioxidant activity of methanolic and ethanolic extracts of aromatic plants' leaves", *International Food Research Journal*, Volume 17, pp. 1077-1084, Malaysia, 2010.

# ANALYSIS OF PHYSICOCHEMICAL AND BIOLOGICAL QUALITY PARAMETERS OF PHULELI CANAL WATER AND WASTEWATER ADJACENT TO HYDERABAD CITY

Sikandar Ali Channa\*, Abdul Qayoom Jakhriani\*\*, Kishan Chand Mukwana\*\*, Sadam Hussain Jakhriani\*\*\*

## ABSTRACT

The purpose of this study was to examine the level of physicochemical and biological parameters of Phuleli canal water and effluents entering the canal along the entire length of Hyderabad city. In this regard, five different locations, each for investigations of canal water and wastewater were selected. The parameters studied were temperature, pH, turbidity, electrical conductivity, total dissolved solids and suspended solids, chlorides, sulfates and nitrate-nitrogen, biochemical oxygen demand (BOD), chemical oxygen demand (COD) and faecal coliforms count. The study confirmed the extraordinary increase of electrical conductivity and total dissolved solids especially during lower flow periods of canal water. Higher level of COD with 1056 mg/l and faecal coliforms with 207 to 867 MPN/100 ml was also recorded, which exceeds permissible surface water limits. It was observed that the level of BOD and COD were increasing with entering of effluents in the canal and decreasing with the passage of time due to self-purification by canal water. The results revealed that the continuous inflowing of untreated or partially treated sewage and industrial effluents into the canal has changed its physicochemical and biological characteristics, which make it unfit for human consumption and can have long-term irrevocable ecological threats if left unmanaged.

**Key words:** *physicochemical characteristics, biological properties, faecal coliforms, wastewater effluents, canal water*

## 1. INTRODUCTION

Water is one of the principal commodities, which human has exploited more than any other resource for sustenance of life. It is commonly referred to as the universal solvent as it dissolves many substances and easily gets polluted. Thus, it is rarely found pure in nature. The major cause of water contamination is receiving of untreated municipal, industrial effluents and hazardous substances from the nearby areas [1, 2]. The characteristic parameters of water bodies indicate its pollution level and quality to be used for household or any other applications [3]. The main physicochemical parameters of water and wastewater are temperature, pH, electrical conductivity (EC), total dissolved solids (TDS), total suspended solids (TSS), turbidity, chlorides, sulfates and nitrates. The biological and microbial parameters include biochemical oxygen demand (BOD), chemical oxygen demand (COD) and presence of coliforms or disease causing bacteria in the water bodies.

### 1.1 Physicochemical and Biological Quality Parameters of Water

Temperature is one of the most important parameters for aquatic environment as it alters the characteristics of the water. The rate of chemical reaction and other biological

activities are reliant on the water temperature. The increase of temperature increases the oxygen demand and decreases the oxygen solubility in water, leading to oxygen depletion problem in the water bodies. The second most important physicochemical parameter is the level of pH, which is a negative logarithm of the hydrogen ion concentration [4, 5]. The value of pH for pure water is 7.0. Its value is less than 7.0 indicate acidic and greater than 7.0 basic nature of waters. The examination of electrical conductivity shows the capacity of ions in a solution to carry electric current. The current is carried out by inorganic dissolved solids such as anions of chloride, nitrate, sulfate and phosphate, and cations of sodium, calcium, magnesium, iron and aluminum. Total dissolved solids consist mainly of inorganic substances, such as calcium, magnesium and sodium, bicarbonates, chlorides and sulfates [6, 7]. The World Health Organization (WHO) guide line value for TDS in drinking water is 500 mg/l and for wastewater is 3500 mg/l. Most surface waters contains suspended solids load due to the presence of dispersed clay, silt, and finely divided organic and inorganic substances and other microorganisms [8]. Quantification of total suspended solids helps to improve the operational efficiency of treatment units and sewerage lines. The turbidity test

\* Assistant Professor, Department of Mining Engineering, Mehran University of Engineering and Technology (MUET), Jamshoro, Sindh, Pakistan

\*\* Assistant Professor, Department of Energy and Environment Engineering, Quaid-e-Awam University of Engineering, Science and Technology (QUEST), Nawabshah, Sindh, Pakistan [\*Email: aquinimas@hotmail.com]

\*\*\* Postgraduate Student, Department of Civil Engineering, Quaid-e-Awam University of Engineering, Science and Technology (QUEST), Nawabshah, Sindh, Pakistan.

measures of optical property of water samples which results from the scattering and absorbing of light by the particulate matter present in it. High levels of turbidity protect the microorganisms from the effect of disinfection and can stimulate the growth of bacteria. The guideline value for turbidity is 5.0 Nephelometric Turbidity Unit (NTU) [9].

Chloride, sulfates and different forms of nitrogen are present in natural water and wastewater bodies with variable concentration levels. The higher level of chlorides in water bodies is either due to the contact with chloride containing geological formations or mixing of sewage and industrial effluents. The chlorides have a corrosive effect on metal pipes and structures. It is also harmful to most trees and plants, if its level exceeds the permissible value. Higher levels of sulfates are mostly attributed to the leaching of magnesium sulfate and sodium sulfate deposits [10]. However, industrial and domestic wastes can also increase its concentration. Various forms of nitrogen with respect to decreasing oxygen level in the water bodies are nitrate, ammonia and organic nitrogen. Nitrate generally occurs in trace quantities in surface waters but may get higher levels in some ground waters. The fertilizer use, decayed vegetable and animal matter, domestic effluents, sewage sludge disposal to land, industrial discharges, leachate from refuse dumps and atmospheric wash outs all contribute to these ions in water sources. Such sources can contaminate the streams, rivers, lakes, and also groundwater bodies.

In addition, organic matter is one of the major pollutants in wastewaters. Generally it is measured as biochemical oxygen demand (BOD) and chemical oxygen demand (COD) [11]. BOD test is one of the major tests to quantify the level of oxygen utilized by microorganisms in the aerobic oxidation of organic matter. This test is also used to determine the relative oxygen requirements of treated effluents and polluted waters. The level of organic pollutants or organic strength of wastewater and pollution of natural waters is determined by COD test. As this test indicates the quality of natural waters and helps to control oxygen consuming (both organic and inorganic) pollutants. Moreover, in the 19th century, microorganisms were identified as the cause of diseases. The microorganisms in wastewater originated mainly from human's excreta, as well as from the food industries. The high concentration of microorganisms may create a severe health risk when raw wastewater is discharged into the receiving water bodies [12]. Human and animal wastes carried to the streams are sources of pathogenic or disease-causing bacteria and viruses. Fecal coliform, Enterococci, and E. coli bacteria are used as indicator organisms. These species indicate the probability of finding the pathogenic organisms in any stream or water body. Unfortunately, most of the industrial effluents and

municipal wastewaters are being disposed-off directly into the surface water bodies in Pakistan, without any treatment. Moreover, no concerns are shown to the proper assessment, monitoring and prevention of water bodies from contaminants. The presence of huge number of organic contaminants in the environment poses potentially precarious consequences [13]. Therefore, it is prime need to establish the information databases, which reveals the level, amount and types of pollutants present in the water bodies.

### 1.3 Background of Phuleli Canal

Hyderabad is located at 25.36°N latitude and 68.36°E longitude with an elevation of 13 m above sea level. It is located on the east bank of the River Indus [14]. Phuleli canal is a main water supply source for both irrigation as well as human consumption for Hyderabad city dwellers as well as in its adjoining areas, which takes-off water from Kotri Barrage. Although, there are facultative ponds for the treatment of municipal wastewaters of the city, yet the network of sewerage lines is not so good to divert all the effluents towards these ponds. Therefore, some part and areas of municipal wastewater as well as toxic industrial effluents are directly disposed-off either by gravity flow or by means of pumping into the Phuleli canal without any treatment [15]. The municipal wastewater which inflows into the Phuleli canal comprised of the areas of cantonment, Hirabad, Khuwaja colony, Silawat para and Northern part of Liaquat colony and old Power House [16]. It also receives the toxic substances emitted from vehicles and bangle industries, liquid wastes generated from slaughter houses and poultries and heavily contaminated industrial affluent from Hala Naka to Husri and also from Zeal Pak cement factory [17, 18]. The increasing level of pollutants in Phuleli canal water put the lives of millions of people residing in Hyderabad, Badin, Tando Muhammad Khan and Matli towns at the risk, as they use this canal water for drinking purpose [19,20]. Such practice is creating serious multi-dimensional problems to the people of Hyderabad city and those living in the downstream areas. Therefore, it is necessary to assess the quality of canal water and wastewater effluents so as to make potential recommendations for the treatment of wastewater inflowing towards canal water. This study is carried out to check the physicochemical and biological characteristics of Phuleli canal water and wastewater effluents at different locations along the entire course of canal passing through the Hyderabad city.

## 2. MATERIALS AND METHODS

A total of ten sampling locations were selected, five each for canal water and wastewater analysis, after conducting preliminary survey of canal along the entire 15 km length of Hyderabad city. The first location was selected at

reduce distance (RD) 04 of Phuleli Canal near Akhund Village before entrance of any wastewater effluents. Three locations were chosen between two main point

sources of wastewater entrance and the last location was taken at RD 45, where canal leaves the city limits as shown in Figure 1.

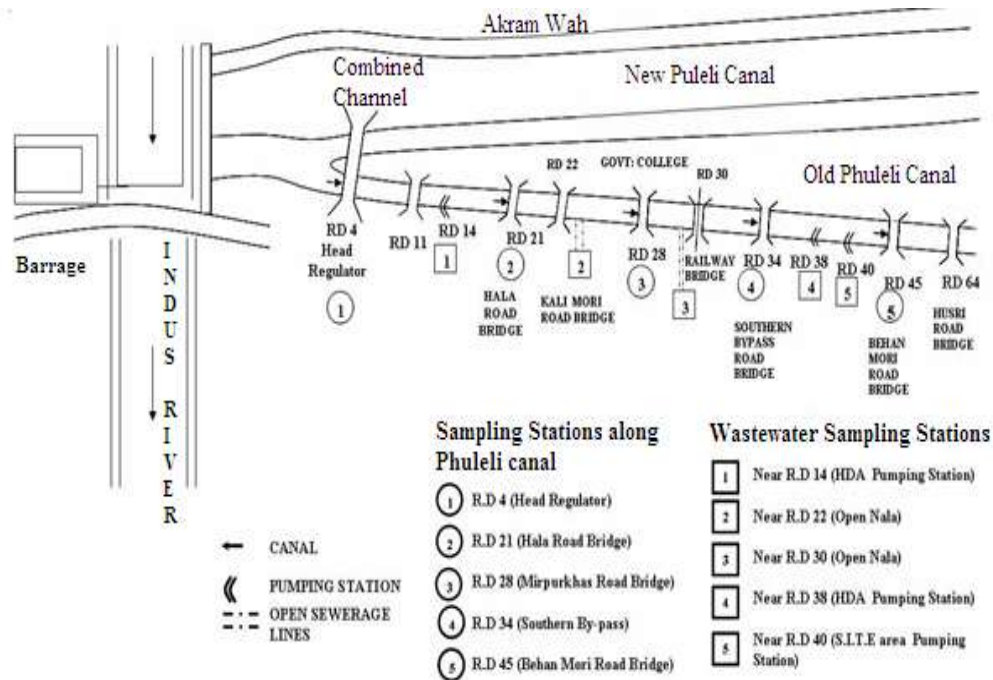

Figure 1. Selected sampling locations on Phuleli canal water and wastewater effluents

An integrated method and composite sampling technique was adopted for the collection of water samples to represent the true picture of canal water quality and water entering the canal. First, the individual grab samples were collected in sterilized plastic and glass bottles from morning to evening at different sewerage lines and then mixed. The bottles were rinsed with canal water and wastewater twice before collection of samples. Then, bottles were properly sealed/labeled and brought to laboratory for analysis. The physicochemical quality parameters namely temperature, pH, electrical conductivity ( $\mu\text{S}/\text{cm}$ ), total dissolved solids (TDS), total suspended solids (TSS), turbidity (NTU), chlorides ( $\text{mg}/\text{l}$ ), sulfates ( $\text{mg}/\text{l}$ ), nitrate-nitrogen ( $\text{mg}/\text{l}$ ) were examined. The microbiological parameter tests were biochemical oxygen demand ( $\text{mg}/\text{l}$ ), chemical oxygen demand ( $\text{mg}/\text{l}$ ) and faecal coliforms count (MPN/100 ml).

The air and water temperatures were measured with the help of Thomas Double-Safe Precision General Purpose Liquid-In-Glass Thermometer, 200mm Length,  $-10^{\circ}\text{C}$  to  $110^{\circ}\text{C}$ , 50mm immersion mercury-glass thermometer. The air temperature was taken 1m above water surface at each sampling location by shading the thermometer from direct sun light. The temperature of canal water and wastewater was recorded by dipping the thermometer directly into the water stream and waiting until the

reading was constant. The pH was recorded using a pre-calibrated PH-2601 PH/Temp Meter by dipping the pre-cleaned electrode in the water samples. The turbidity of the samples was recorded by 2020e/2020i Turbidity Meter Jackson turbidity tube following the standard procedure. The level of total dissolved solids and electrical conductivity was determined through a pre-calibrated ELE-515, Bench-top TDS, Conductivity meter, by immersing pre-cleaned electrodes in the samples and total suspended solids through spectrophotometer. Chlorides were determined by Mohr Method, in which 10ml sample was titrated with Silver Nitrate (0.025N) after adding 1ml of Potassium Chromate as an indicator. The level of sulfate in the water samples was determined by titration method and dissolved oxygen test by Winkler method.

The biochemical oxygen demand ( $\text{BOD}_5$ ) test was carried out by means of difference of dissolved oxygen (DO) level in water samples before and after incubation. First the dissolved oxygen (DO) level of samples was examined and then the samples were kept in an incubator at  $20^{\circ}\text{C}$  for five days. After incubation period, the dissolved oxygen level of the samples was again determined. The  $\text{BOD}_5$  was calculated from the difference of dissolved oxygen before and after incubation. The chemical oxygen demand (COD) test was conducted



using COD meter, model HI 83214 accordance with EPA 410.4 and ISO 15705:2002 standards. The most probable number (MPN) technique was adopted for the determination of bacteriological analysis of samples.

### 3. RESULTS AND DISCUSSIONS

The results of physicochemical and biological characteristics of Phuleli canal water and wastewater samples are illustrated in Figures 2-8. It was established from the study that the temperature of wastewater was slightly higher than that of canal water. However, the results were within the range of 23.0 to 38.0°C during the study period. The slightly higher temperature of the samples may be due to the presence of pollutants with various thermal properties. The level of pH in canal water at location 1 was ranging between 7.7 and 8.6, whereas the pH level in rest of the samples was between 7.2 and 8 as shown in Figure 2. It was observed that the level of pH in the samples was less basic except the sample taken from location 1. This could be due to development of free CO<sub>2</sub> resulting the lower level of dissolved oxygen and ultimately pH of canal water. However, all pH values of canal water samples were within the WHO standards.

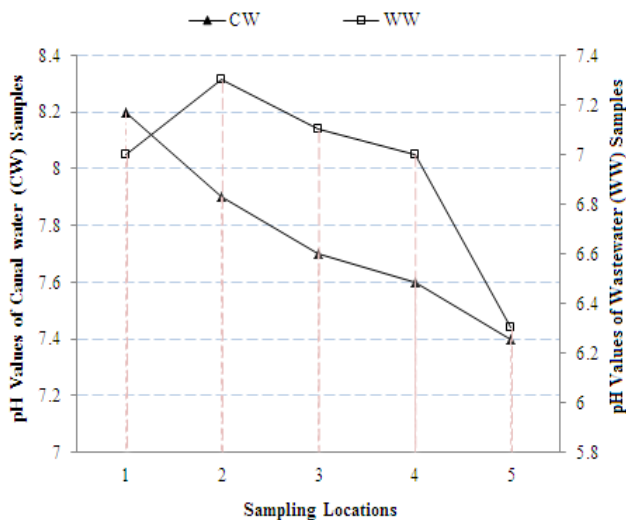

Figure-2. Average pH level in canal water and wastewater samples

The level of pH in wastewater samples during study period were between 5.1 and 8.0 indicating the acidic to alkaline nature of sewage. Acidic pH with mean value of 6.3 was observed at location 5, while the rest of wastewater samples were neutral to slightly alkaline. The results revealed that the sewage effluent contained the composite mixtures of varied nature of complex acidic to alkaline substances. But slightly acidic pH at location 5 could be due to the higher concentration of acidic material mixed with sewage that lowered the pH levels. However, all the pH values of wastewater samples were within the NEQS range of 6.0 -10.0.

### 3.1 Electrical Conductivity and Total Dissolved Solids

The average level of electrical conductivity (EC) and total dissolved solids (TDS) in canal water and wastewater are shown in Figure 3. It is observed from the analysis of canal water samples that the level of EC was 434μS/cm at location 1. There was positive shift in the base line of electrical conductivity from location 2 to 5 along the entire length of Phuleli canal. The average maximum rise in the electrical conductivity was 1051μS/cm found from location 4 near Bhatti village. That rise of values could be attributed to the influx of large fraction of wastewater from the adjoining open sewerage lines near old power house. The results reflected that the wastewater is liable for elevating the electrical conductivity level in canal water samples from location 2 to 5 as compared to the reference location 1. It was observed that the samples taken from locations 3 to 5 showed higher values than the WHO guideline value of 800μS/cm.

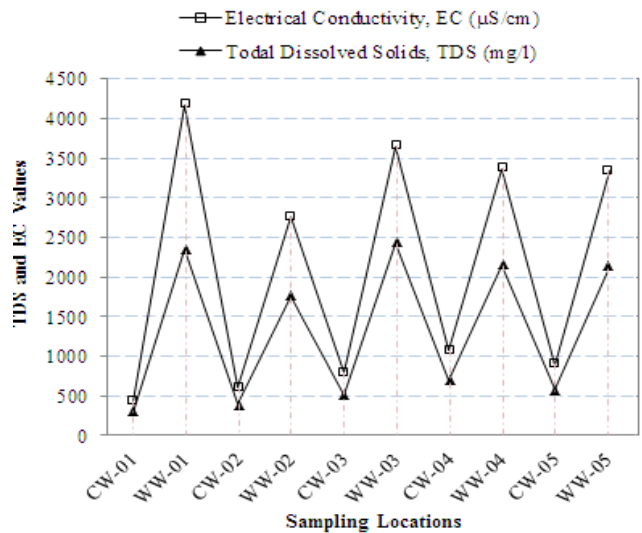

Figure-3. Average TDS and EC level in canal water and wastewater samples

During investigation period, the electrical conductivity of wastewater samples reached its upper limit of 5628μS/cm at location 1, while lower limit was recorded at location 2 with 1327μS/cm. The maximum average value of sewage EC was found 4182μS/cm at location 1, whereas, the average observed value of EC was less than 3600 μS/cm in other locations. It was revealed that the presence of large amount of electrolytic substances elevated the conductance of wastewater samples taken from location 1 as compared to other points. Since, all wastewater samples showed higher values than NEQS guideline value of 900μS/cm.

The concentration of total dissolved solids in wastewater samples were found to be from 849 mg/l to 3606 mg/l, with maximum average value of 2676 mg/l recorded from the sample taken from location 1, and minimum average

value of 1769 mg/l from location 2. The higher level of TDS at location 1 indicates the presence of large amount of in-organic components in wastewater samples. Since, the average values of all the wastewater samples were within the NEQS limits.

### 3.2 Total Suspended Solids and Turbidity

The average values of total suspended solids (TSS) and turbidity level of canal water and wastewater are given in Figure 4. The average level of TSS at location 1 was 652 mg/l, with the variation of 487 - 964 mg/l. The overall values of TSS were fluctuated between 466 and 727 mg/l from location 2 to 5. The lowest average TSS value of 575 mg/l was recorded from the samples taken from last location. The increase in the concentration of TSS could be attributed to the mixing of un-treated municipal wastewater coming from various open drains which were highly loaded with finely divided organic and inorganic matter, microorganisms, silt and suspended clays. The decrease in TSS at sampling location 5 could be ascribed to the dilution factor as well as the self-settling and purification process of the canal.

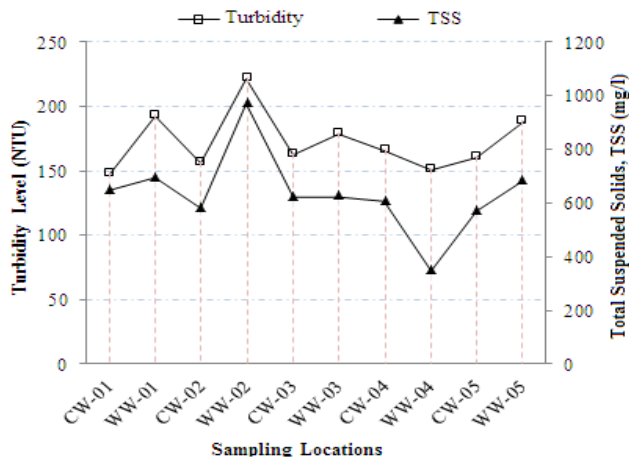

Figure-4. Average turbidity and TSS level in canal water and wastewater samples

The concentration of suspended solids in wastewater samples was observed in the range of 284 mg/l to 1135 mg/l, with average maximum of 972 mg/l from location 2 and average minimum of 354 mg/l from location 4. The average maximum value was 2.75 higher than the average minimum recorded from location 4. This may be due to an open sewerage line passing through thickly populated area of the city containing large amount of suspended solids at location 2. Since, it was observed that the TSS values in all wastewater samples were higher than the NEQS value of 200 mg/l.

The turbidity of canal water was mainly due to silt contents produced because of high water discharge during the period of study. The observed values of turbidity in canal water samples were 121 to 214 NTU. The mean

maximum value of 166 NTU was noted at location 4, while mean minimum value was 148 NTU recorded from the samples of location 1. The increasing values of turbidity from location 2 to 5 could be ascribed to the addition of highly turbid wastewater through different sewage outlets of the city.

Turbidity is a reciprocal of clearness as it is directly related to the level of suspended solids. The turbidity values of wastewater samples were varied from 129 NTU to 241 NTU. The maximum average value of 223 NTU noted at location 2, and minimum average 151 NTU at location 4. Highest values of turbidity at location 2 may be due to the presence of greater amounts of non-filterable residues, whereas, the lowest values of were observed at location 4.

### 3.3 Chlorides and Sulfates

The average values of chlorides and sulfates in canal water and wastewater samples are given in Figure 5. It was observed during investigations that the values of chlorides in canal water samples were between 46 mg/l and 101 mg/l with their mean value of 69 mg/l. The considerable changes in the concentration of chloride content were detected from location 2 to 5 as the result of mixing of wastewater from numerous sewerage lines with the fresh canal water. The overall fluctuation in the chlorides from location 2 to 5 was between 61 mg/l and 122 mg/l. The maximum average rise in concentration with 89 mg/l was found at location 2. This could be due to the influx of large fraction of salinity rich wastewater from the Cantonment Board Sewage Pumping Station near Barkat colony or Jacob tanks. Comparatively lower values of chlorides were recorded at the last sampling location, which indicate the absence of major external sources, dilution factor and high flow rate of the canal water. Since, all the observed values of chlorides in canal water samples were below the WHO standard of 250 mg/l.

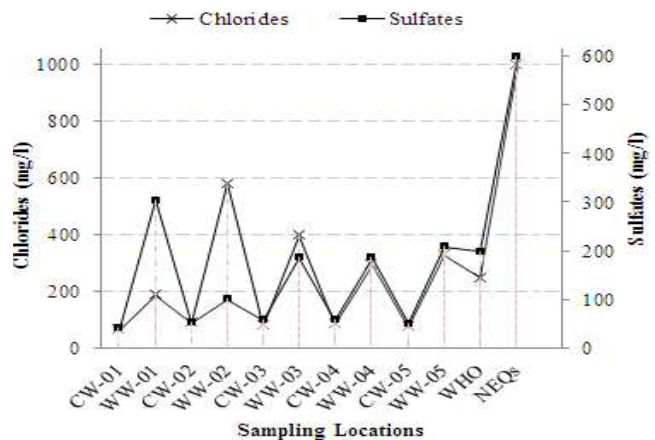

Figure-5. Average level of chlorides and sulfates in canal water and wastewater samples

The concentration of chlorides in wastewater samples were found to be between 141 mg/l and 823 mg/l. The mean maximum value of 580 mg/l was found from the samples taken at location 2 and mean minimum value 190 mg/l at location 1. The higher values at locations 2 and 3 could be due to the sewage coming from thickly populated areas of the city, as well as washouts from small scale manufacturing units of caustic soda, bleaching powder and dyes etc. Since, all the measured values from wastewater samples were below the NEQS limit of 1000 mg/l.

Moreover, the mean value of sulfate concentration was recorded 42 mg/l in the canal waters, which ranges from 36 to 54 mg/l at location 1, before the introduction of sewage from the city. The values of sulfate content were fluctuated between 44 mg/l and 73 mg/l from location 2 to 5 with maximum average of 59 mg/l at location 4 and the minimum average of 52 mg/l at location 5. The results revealed that the considerable influence of sewage elevated the sulfate content in canal water samples. However, the overall values of sulfates were within the WHO guideline value of 200 mg/l.

In wastewater samples, the sulfate concentration was found to be between 90 mg/l and 472 mg/l. The mean maximum value was 304 mg/l recorded at location 1 and mean minimum value 101 mg/l at location 2. The higher concentration of sulfate at location 1 could be attributed to the entrance of excreta, animal dung coming from cattle farms and washouts of small scale detergents, paints and pigments processing units in the nearby areas. However, the results of all wastewater samples were within NEQS value of 600 mg/l.

### 3.4 Nitrate-N

In canal water samples, the level of Nitrate-N was between 4.4 mg/l and 7.7 mg/l as shown in Figure 6.

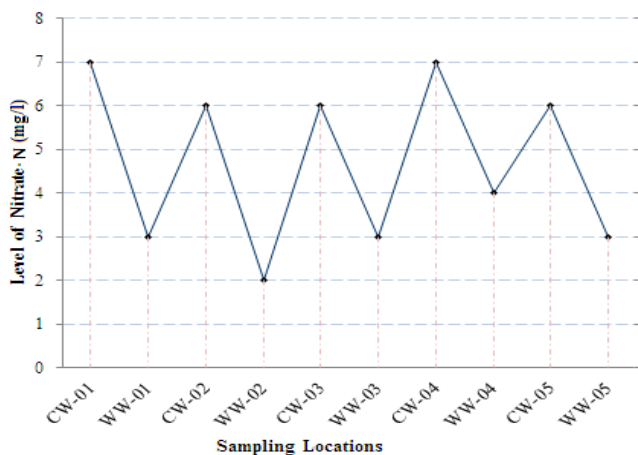

Figure-6. Average level of Nitrate-N in canal water (CW) and wastewater (WW) samples

The lowest average concentration was 5.6 mg/l found at location 4 and highest average was 6.47 mg/l at location 1. These results reflected that aerobic bacteria become more active in bringing about the oxidation at location 1, in the presence of higher concentration of oxygen and low oxygen demand as compared to location 4, where denitrification process could be dominant due to lower level of dissolved oxygen and higher oxygen demand. Since, nearly all the canal water samples showed lower values than WHO standard of 10 mg/l.

The concentration of Nitrate-N in wastewater samples was in the range of 1.39 mg/l to 5.4 mg/l with the highest average of 3.58 mg/l at location 4 and the lowest average of 2.28 mg/l at location 2. It was observed that the samples taken from locations 2 and 3 showed lowest concentration of Nitrate-N, as there was an open drain. This may be due to the de-nitrification of nitrate into free N<sub>2</sub> and NH<sub>3</sub> due to higher oxygen demand.

### 3.4.5 Biochemical Oxygen Demand (BOD) and Chemical Oxygen Demand (COD)

The level of biochemical oxygen demand (BOD) and chemical oxygen demand (COD) in canal water samples are shown in Figure 7. The average level of BOD in canal water was 14.5 mg/l at noted from the canal water samples at location 1. The maximum average level of BOD was found at location 4 with 30.6 mg/l and minimum average was 19.0 mg/l at location 2. Since, the overall BOD level was ranged from 13.0 to 43 mg/l. The significant changes in the level of BOD were observed from location 2 to 5. These were attributed to the consequence of wastewater introduction from five sewerage lines. The elevated level of BOD in the canal waters was corresponding to the maximum depletion of dissolved oxygen.

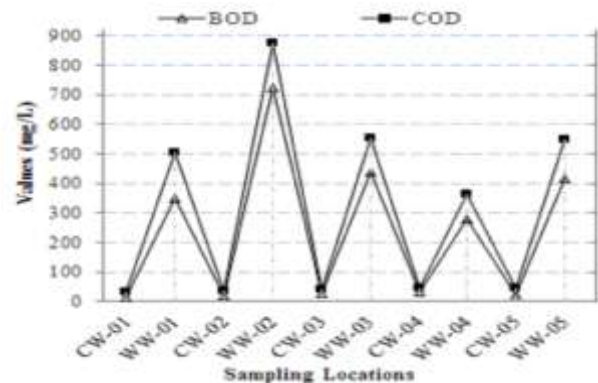

Figure-7. Average level of BOD and COD in canal water and wastewater samples

In wastewater samples, the higher values of BOD were found at location 2. The BOD values of wastewater samples were in the range of 221 mg/l to 864 mg/l with average maximum of 724 mg/l at location 2 and average

minimum of 281 mg/l at location 4. Since, it was established that all examined wastewater samples showed three times higher values than NEQS value of 80 mg/l.

Furthermore, the mean concentration of COD in canal water was 30 mg/l at sampling location 1, where the fluctuation of COD was within 20 to 42 mg/l. The average maximum level in COD in the canal waters was 45.6 mg/l at sampling station 5 and minimum average was 37 mg/l at sampling location 2. It was found that the COD level was fluctuated between 32 and 66 mg/l during study period. The significant changes in the concentration of COD from sampling location 2 to 5 were observed as a consequence of wastewater introduction to the canal water.

The maximum average value of COD in wastewater was 873 mg/l at sampling location 2 while the minimum average value was 362 mg/l was estimated at sampling location 4. The overall fluctuation of COD in wastewater was between 298 and 1056 mg/l, whereas the NEQS value is 180 mg/l. The higher value of COD at sampling location 2 and 3 reflect the strength of organic matter.

### 3.5 Faecal Coliforms Count

The identification of faecal coliform bacterial count is very important as they provide a measure the degree of water contamination in the surface water bodies. The results of faecal coliforms colonies in canal water and wastewater samples are shown in Figure 8.

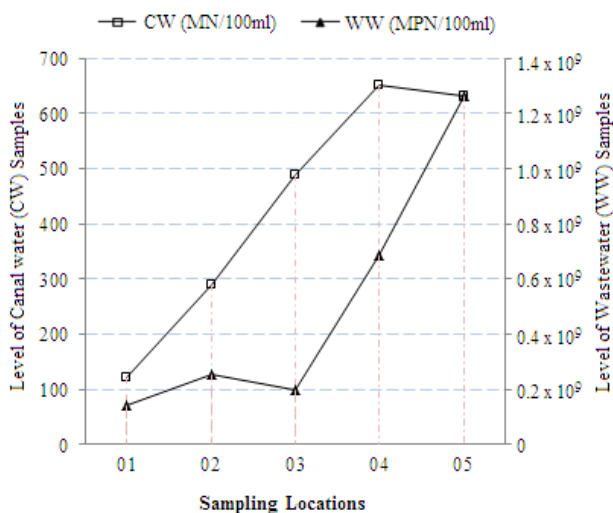

Figure 8. Average level of fecal coliforms in canal water and wastewater samples

The faecal coliform bacterial load in the examined samples of canal water was between 78 and 216 MPN/100 ml. The average bacterial count of 120 MPN/100 ml was noted in the samples taken from location 1, and 207 to 867 MPN/100 ml from location 2 to 5 respectively. The minimum average level of the

faecal coliform bacterial concentration was 290 MPN/100 ml recorded at location 2, whereas, the maximum mean value was 650 MPN/100 ml at location 4, which was about 5.4 times higher than the mean of the bacterial number estimated at location 1. The above findings provide a clear indication that there is marked impact of sewage on the canal water from locations 2 to 5. As the canal flows further downstream, the bacterial pollution load decreases due to dilution factor and self-purification process of the canal. The WHO guideline value for faecal coliform in drinking water is 0.00 MPN/100 ml.

The faecal coliform bacterial load in the wastewater samples was recorded between  $1 \times 10^7$  -  $9.2 \times 10^8$  MPN/100 ml. The minimum and maximum average level of the faecal coliform bacterial load was  $1.1 \times 10^8$  MPN/100 ml and  $2.5 \times 10^8$  MPN/100 ml at the location 4 and 2 respectively. The high bacterial load at location 2 was due to the presence of considerable amounts of organic matter which was verified by high biochemical oxygen demand. All the wastewater samples showed higher concentration than NEQS value of 1000 MPN / 100 ml for irrigation.

### 4. CONCLUSIONS

The purpose of this study was to examine the level of physicochemical and biological quality parameters of Phuleli canal water and effluents entering the canal along the entire extent of Hyderabad city area. The first sampling location of canal water was taken as reference point to compare the level of pollutants in the canal.

- The results revealed that the continual inflowing of untreated or partially treated sewage and industrial effluent into the canal has changed the physicochemical and biological characteristics of canal water.
- The electrical conductivity of wastewater was found to be around 5628  $\mu\text{S}/\text{cm}$  at few locations, which indicated the presence of electrolytic substances in the sewage. The level of EC increased up to double during lower flow conditions as compared to higher periods.
- The prominent aspect of sewage was seen at location 2 and 3, as there was low level of dissolved oxygen and high level of COD with 1056 mg/l.
- The microbial study of canal water indicated the presence of faecal coliforms in the canal water samples with 207 to 867 MPN/100 ml, exceeding permissible surface water limits.
- The rise in the nutrient was noted in the samples that may be responsible for the speedy growth of biological organisms and ultimately create oxygen deficit situation in the canal water.

It is established that the canal water was being contaminated because of inflowing of un-treated



wastewater and industrial effluents. Such situation may be the major cause of irreparable ecological harm in the long-term basis if left unmanaged.

#### ACKNOWLEDGEMENT

The authors would like to thanks the authorities of Mehran University of Engineering and Technology (MUET) Jamshoro and Quaid-e-Awam University of Engineering, Science and Technology (QUEST), Nawabshah, Sindh, Pakistan for providing laboratory facilities to conduct the research.

#### REFERENCES

- [1] Obeidat, M. M., Awawdeh, M., & Al-Mughaid, H. (2013). Impact of a domestic wastewater treatment plant on groundwater pollution, north Jordan. *Revista mexicana de ciencias geológicas*, 30(2), 371-384.
- [2] Jakhriani, A. Q., Samo, S. R., & Nizamani, I. (2009). Impact of wastewater effluents on physico-chemical properties of groundwater. *Sindh University Research Journal (Sci. Ser.)*, 41(1), 75-82.
- [3] Hanley, N., Wright, R. E., & Alvarez-Farizo, B. (2006). Estimating the economic value of improvements in river ecology using choice experiments: an application to the water framework directive. *Journal of environmental management*, 78(2), 183-193.
- [4] LeBlanc, R. T., Brown, R. D., & FitzGibbon, J. E. (1997). Modeling the effects of land use change on the water temperature in unregulated urban streams. *Journal of Environmental Management*, 49(4), 445-469.
- [5] Shinde, S. E., Pathan, T. S., Raut, K. S., & Sonawane, D. L. (2011). Studies on the physico-chemical parameters and correlation coefficient of Harsool-Savangi Dam, District Aurangabad, India. *Middle-East Journal of Scientific Research*, 8(3), 544-554.
- [6] Jakhriani, A. Q., Samo, S. R., Siyal, Z. A., Sobuz, H. R., Uddin, M. A., & Hasan, N. M. S. (2012a) Evaluation of Dissolved Salts and Heavy Metals in Groundwater. *International Journal of Structural and Civil Engineering*, 1(2), 54-60.
- [7] Jakhriani, A. Q., Samo, S. R., Sobuz, H. R., Uddin, M. A., Ahsan, M. J., & Hasan, N. M. S. Assessment of Dissolved Salts Concentration of Seawater in the Vicinity of Karachi. *International Journal of Structural and Civil Engineering*, 1(2), 61-69.
- [8] Bilotta, G. S., & Brazier, R. E. (2008). Understanding the influence of suspended solids on water quality and aquatic biota. *Water research*, 42(12), 2849-2861.
- [9] Crump, J. A., Okoth, G. O., Slutsker, L., Ogaja, D. O., Keswick, B. H., & Luby, S. P. (2004). Effect of point-of-use disinfection, flocculation and combined flocculation–disinfection on drinking water quality in western Kenya. *Journal of Applied Microbiology*, 97(1), 225-231.
- [10] Chin, D. A. (2012). *Water-Quality Engineering in Natural Systems: Fate and Transport Processes in the Water Environment*. John Wiley & Sons.
- [11] Rasel, H. M., Hasan, M. R., Ahmed, B., & Miah, M. S. U. (2013). Investigation of soil and water salinity, its effect on crop production and adaptation strategy. *International Journal of Water Resources and Environmental Engineering*, 5(8), 475-481.
- [12] Toze, S. (2006). Reuse of effluent water—benefits and risks. *Agricultural water management*, 80(1), 147-159.
- [13] Shaikh, H., Memon, N., Bhangar, M. I., & Nizamani, S. M. (2014). GC/MS Based Non-target Screening of Organic Contaminants in River Indus and its Tributaries in Sindh (Pakistan). *Pak. J. Anal. Environ. Chem.* Vol, 15(1), 42-65.
- [14] Memon, N. A., Unar, M. A., Ansari, A. K., Khaskheli, G. B., & Memon, B. A. (2008). Prediction of parametric value of drinking water of Hyderabad City by artificial neural network modeling. *WSEAS Transactions on Environment and Development*, 8(4), 707-716.
- [15] Sohag, M. A., & Syed, M. A. (2014). Pollution and Encroachment of Phuleli Canal along the Periphery of Hyderabad City of Pakistan. *Am. J. Biomed. Sci.*6(2), 72-81.
- [16] Laghari, A., Chandio, S. N., Khuhawar, M. Y., Jahangir, T. M., & Laghari, S. M. (2004). Physico-chemical study and budgeting of wastewater from Hyderabad City limits. *J. Biol. Sci.* 4, 317-322.
- [17] Mastoi, G. M., Palh, Z. A., Lashari, K. H., & Naz, A. (2014). To study the effect of iron load on plasma minerals and hematological parameters in thalassemia patients. *Journal of Applied Science and Research*, 2(5), 26-33.
- [18] Qureshi, S., Mastoi, G. M., Ghanghro, A. B., & Mastoi, A. W. (2012). Impact of Sewage Water on Quality of Fullali Canal Water, Hyderabad, Sindh, Pakistan. *Springer Vienna*, 191-197.
- [19] Soomro, A., Siyal, A. A., Mirjat, M. S., & Sial, N. B. (2014). Seasonal variations of trace elements and heavy metal concentrations in Phuleli canal water (Sindh), Pakistan. *Sarhad Journal of Agriculture*, 30(1), 73-82.
- [20] Soomro, A., Siyal, A. A., Mirjat, M. S., & Sial, N. B. (2013). Seasonal Variability of Trace and Heavy Metals Concentration in Groundwater and its Quality for Drinking and Irrigation Purpose under Phuleli Canal Command Area (Sindh), Pakistan. *Journal of Basic and Applied Sciences*, 9, 550-561.

# MEDICINAL PLANTS' USE IN AND AROUND KALINZU CENTRAL FOREST RESERVE, BUSHENYI – WESTERN UGANDA

Mumtaz Ahmed Sohag\*, Musinguzi Danson\*\*

## ABSTRACT

This study assessed medicinal use, the environmental diversity and conservation of medicinal plant species and to evaluate how significant medicinal plants were used in the treatment of various ailments among the local communities. Kalinzu CFR is a natural tropical forest in Western Uganda whose existence is threatened by the increasing human population and pressure for demand of its wood and non-wood resources for medicinal use.

Tools used included stratified random sampling, structured questionnaires, to select and obtain information on local plant species used for medicinal purposes, the parts used, modes of their preparation and applications as well as the ailments treated was obtained. In-situ physical study on the plant species and Floristic information on the plant species was obtained by transects and quadrant methods made from the six sub-counties adjacent to Kalinzu's forest interior. Small eight sample plots of dimensions 30m length by 15m width were made on each transect line separated by a distance of 100m using tape measures and marked with flagging tapes. The study used quantitative techniques of data analysis involving Shannon Weiner Index.

The results showed 18 species, belonging to 13 families and 16 genera used by the local communities. Forest products included fruits; vegetables, medicines, firewood, construction materials or other purposes, but a greater percentage uses the forest for medicinal values (76.7%). Plant leaves (42.5%) and bark (30%) were the most common plant parts used for medicinal purposes. Trees were the major sources of medicines as observed (50%) followed by shrubs (27.8%). The plant species most used were in the families' fabaceae (16.7%) and lamiaceae (16.7%) while the least species used were in the family menispermaceae (5.6%). Plants at the edges of the forest were harvested more frequently than those in the interior of the forest due to proximity. There were minimal local community conservation initiatives of medicinal plants (89%) as compared to 11% of the people who had cultivated plant species that were increasingly harvested or their habitats destroyed.

In conclusion, harvesting methods and traditional status of individuals that make medicinal plants the basic primary health care comparing to expensive and inaccessible western medicines is a factor hindering effective implementation of conservation measures. Besides, there is great need to educate and involve the communities in species conservation projects.

**Keywords:** Diversity, Medicinal plant, Plant species, Fabaceae, Menispermaceae

## 1. INTRODUCTION

Indigenous communities all over the world use plants for various purposes such as medicine, fuel, food, manure, construction materials, crafts and several other domestic uses [1]. Developing countries lying in the tropics like Uganda have used tropical plants as a great source of medicines, especially traditional medicine, which is useful in the treatment of different diseases. The modern pharmaceuticals also rely on medicinal plants for their modern medicines [2]. Traditional medicines derived from plants have not only played a role in providing healing of various ailments, but have also contributed to the discovery of most pharmaceutically active substances

in plants, which have been used in the commercial production of modern medicines. It is estimated that 90% of the population in developing countries rely on the use of medicinal plants to help them meet their primary health care [3]. Apart from the importance of medicinal plants in the primary health care systems of local communities, medicinal plants also improve the economic status of local people involved in their sales in markets all over the world [4]. However, there has been a tendency of deforestation, over-grazing, over harvesting and bush burning, which has contributed to depletion of different useful plant species [5].

The highest numbers of plants collected by the people are

\* Dean – Engineering & Applied Sciences, Kampala International University, Uganda.

\*\* Lecturer & PhD Scholar, Kampala International University, Uganda.



in the category of medicinal and aromatic plants [6]. About 50,000 of the flowering plant species occurring in the world have been studied for their medicinal purposes [7]. These flowering plants occur in many families, with some of the families having more medicinal plant species than others. The most species rich medicinal plant families include Fabaceae, Asteraceae and Lamiaceae [8].

In traditional medicine, different plant parts are used to treat different diseases and are prepared in various ways; and the modes of preparation and application differ from one healer to another [9]. For medicinal purposes, plant leaves, stems, barks, fruits and roots are often used. This is smeared, rubbed or drunk by the patient. The knowledge of use and application of a traditional medicine is closely bound up with the way of life and culture of the people.

However, increasing demands for medicinal plants locally and internationally have resulted in the over-exploitation and indiscriminate over harvesting of medicinal plant species. The degree of distribution and disturbance of the species population and vulnerability depends on the demand and supply; the part used, and the life span, of the scarce slow growing forest species, (Robbins, 2000). The kind of harvesting technique is important in the use and conservation of medicinal plants as some may be destructive [10]. Interests in medicinal plants as re-emerging health aid have been fueled by the increasing costs of drugs prescription in the maintenance of personal

health and well-being, and the bio-prospecting of new plant-derived western drugs. Land clearance and harvesting of forests for charcoal, medicinal and food use, are having a detrimental effect on the wild medicinal resources [11]. However, the value of indigenous knowledge in agriculture, agro forestry and rural development has become increasingly recognized over the decade.

## 2. PURPOSE OF THE STUDY

The study documented medicinal plants used by local communities living around Kalinzu Central Forest Reserve. In the recent years, forests have been viewed as a source of national revenue with timber as the prominent product. However, in the vague of fast disappearing forest cover, great interest is needed to be attached in non-timber forest products which range from gums, resins, fruits, flowers, seeds and seed derivatives, whole plant, leaves, roots, or stem bark and other forms of medicines [12-13]. The traditional medicines and pharmaceuticals derived from forests have today played an important role in the primary health care (PHC) of millions of people [14-15]. The study therefore, was to increase a descriptive capacity and rationality of different medicinal plant taxonomies used by the communities living around Kalinzu forest, and to enhance community awareness by providing information to improve their conservation values.

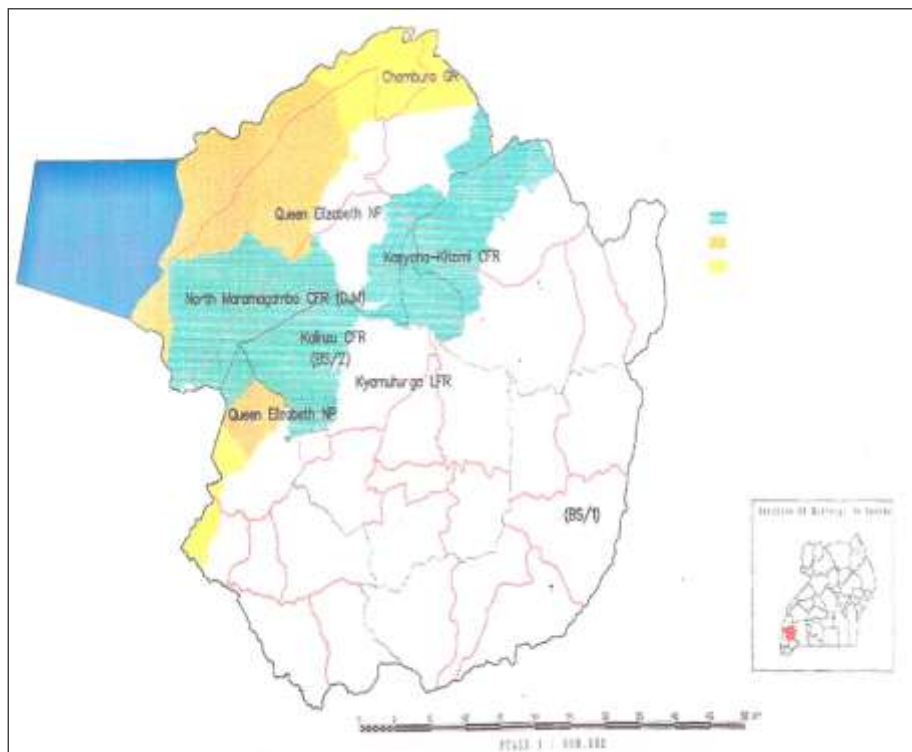

Figure-1: Map of Bushenyi District showing the location of Kalinzu CF

### 3. RESULTS AND DISCUSSIONS

The study results revealed that in traditional medicine, different plant parts are commonly used to treat various diseases, although the modes of preparation and application differ from one species to another and one healer to another [9]. Flowering plants occur in many families, with some of the families having more medicinal plant species than others. The species that are rich belonging to medicinal families are Fabaceae, Lamiaceae and Asteraceae [8]. Therefore, the research findings of the study were in agreement with the findings of above mentioned researchers. The results revealed that medicinal plant species in Kalinzu Central Forest Reserve and grasslands around are diverse in types and their parts used for the treatment of diseases, with the leaves (42.5%) bark (30%) and roots (20%) being the most commonly harvested parts used in herbal medicinal preparations.

The medicinal plants were used to treat many kinds of diseases such as sexual disorders, fevers, pressure, digestive disorders, STDs and common colds to mention a few. For medicinal purposes, plant decoctions of leaves, barks, stems, roots or flowers are often used. This is either

drunk or applied externally on the body or part affected on a patient.

A total of 18 medicinal plant species were identified in the study conducted in the six villages of Swazi, Kishunju, Kyamuhunga, Butare, Kayanga, and Mashonga during the excursions into Kalinzu Central Reserve. Medicinal plant species were observed in different growth forms and morphological structures; these treated either one or more diseases or were found cross-cutting. This meant that some species work best when mixed together during their preparation as decoctions or infusions. In some circumstances, decoctions had common methods of preparation while others could differ in their methods of preparation and applications. Below are descriptions of identified medicinal plants for their preparations, applications and the ailments they treat.

The plant of *Albizia coriaria* belongs to the family fabaceae, local named Runyankole (omusisa) Figure-2 and Figure-3. Growth habit of the tree has bi-pinnate leaves and its trunk is often twisted, with rough and raggedly scaled grey-black bark. It bears many flowers, with sweet smell and is white with red stamen filaments.



Figure – 2: Tree



Trunk



Leaves



Figure-3: Plants of American worm weed are used for children’s convulsions, constipation, chest pain, cough and asthma, stop vomiting, headache, expels intestinal gas and stomachache and treats stomach worms in children.

Results from the forest's sampled plots show that species throughout the forest are not evenly distributed and there was a decline in availability of most medicinal plant species with the increasing distance into interior of the forest. Also, some medicinal species showed a general decline in their abundance due to habitat destruction and unsustainable harvesting methods. Medicinal plant species were reported to re-grow but at a slower rate than individuals could harvest them, an indication that the species were likely to disappear in the future. About 89% of the local people including (THS, TBAs and TMPs); do not practice conservation of medicinal plant species on their farmlands. Only 11% of the population conserves these species by cultivating them in gardens or around

homesteads or in fallow lands.

Eighteen medicinal plants, both cultivated and wild, (Table-1) were documented and identified in the study area. The abundance and distribution of medicinal plant species in different diameter size classes is presented (Table-2). These were grouped into pairs transects for analysis, that is to say, transect TD1 and TD2, transect TD3 and TD4, and transect TD5 and TD6. Most of the medicinal plants utilized by the local populations living around Kalinzu forest are got from wild, often in grasslands within the peripherals of the forest. However, fewer medicinal plant species were cultivated in farmlands or preserved in fallow lands.

**Table-1 Medicinal plant species, cultivated and wild used by communities living around Kalinzu Central Forest Reserve**

Cultivated plant species		Wild plant species	
Botanical	Local name	Botanical name	Local name
Aloe ferox*	Rukaka/ Omujaaja	Aloe ferox *	Rukaka /enkokomtaya Kamaramahano
Ocimum suave*	Omuteete	Eurphobia hirta	Outotoima
Cymbopogon citratus	Ensogasoga	Hoslundia opposita	Ekikuzanyena
Ricinus communis*	Muringa	Warburgia ugandensis	Kifaru
Moringa oleifera	Niimu	Chenopodium ambrosiosides	Omujaaja
Azadirachta indica		Ocimum suave*	Omugabagaba or omukyola ekibirizi
		Senna didymorbortrya	
		Vernonia anygalalina	
		Spathodea campanulata	Omunyara
		Basella Alba	
		Erythrina Abyssinica	Enderema
		Ricinus communis*	Ekiko
		Leonotis nepatae folia	Ensogasoga
		Ficus natalensis	Ekicumucumu
		Albizia coriaria	Omutoma Omusisa

\*Represent those medicinal plant species that exist both cultivated and in the wild

**Table-2 Frequency of distribution of medicinal plant species in Kalinzu Central Forest Reserve (f = 173).**

S. No.	Botanical name	Frequencies of species per transect						Total
		TD1	TD2	TD3	TD4	TD5	TD6	
01	<i>Aloe ferox</i>	00	01	00	00	03	02	06
02	<i>Euphorbia hirta</i>	00	00	01	02	02	00	05
03	<i>Hoslundia opposita</i>	06	00	02	01	00	01	10
04	<i>Warburgia ugandensis</i>	02	05	04	01	00	00	12
05	<i>Chenopodium ambrosioides</i>	00	04	01	00	00	02	07
06	<i>Ocimum suave</i>	03	01	00	00	01	01	06
07	<i>Senna didymorbortrya</i>	04	01	06	00	03	00	14
08	<i>Vernonia amygdalina</i>	02	05	05	07	01	06	26
09	<i>Cymbopogon citratus</i>	00	00	00	00	00	00	00
10	<i>Spathodea campanulata</i>	04	01	01	05	00	00	11
11	<i>Basella alba</i>	01	00	04	06	00	00	11
12	<i>Erythrina abyssinica</i>	00	00	03	02	00	02	07
13	<i>Ricinus communis</i>	08	04	03	05	06	04	30
14	<i>Leonotis nepetae folia</i>	01	03	00	05	00	01	10
15	<i>Ficus natalensis</i>	02	02	00	05	00	03	12
16	<i>Moringa oleifera</i>	00	00	00	00	00	00	00
17	<i>Albizia coriaria</i>	01	00	02	00	03	00	06
18	<i>Azadirachta indica</i>	00	00	00	00	00	00	00
TOTAL								f=173

Key: Transect Name: TD1 = Swazi transect TD2= Butare transect TD3 = Kyamuhunga transect TD4 = Kishunju transect TD5 = Kayanga transect TD6 = Mashonga transect

**Table-3: Medical Plant species' abundance percentages, density and diameter size classes (Dbh) of observed species (n = 18)**

Botanical name	Species (%)	Sp.density	Dbh /cm	Frequency (F)
<i>Aloe ferox</i>	3.2	0.28	-	06
<i>Euphorbia hirta</i>	2.7	0.23	-	05
<i>Hoslundia opposita</i>	5.4	0.46	0.70	10
<i>Warburgia ugandensis</i>	6.5	0.56	160.0	12
<i>Chenopodium ambrosioides</i>	3.8	0.32	-	07
<i>Ocimum suave</i>	3.2	0.28	0.20	06
<i>Senna didymorbortrya</i>	7.6	0.65	12.7	14
<i>Vernonia amygdalina</i>	14.1	1.20	14.4	26
<i>Cymbopogon citratus</i>	3.8	0.32	-	07
<i>Spathodea campanulata</i>	5.9	0.50	125.2	11
<i>Basella alba</i>	5.9	0.50	0.40	11
<i>Erythrina abyssinica</i>	3.8	0.32	109.9	07
<i>Ricinus communis</i>	16.3	1.39	11.1	30
<i>Leonotis nepetae folia</i>	5.4	0.46	0.50	10
<i>Ficus natalensis</i>	6.5	0.56	73.2	12
<i>Moringa oleifera</i>	1.1	0.09	19.7	02
<i>Albizia coriaria</i>	3.2	0.28	179.6	06
<i>Azadirachta indica</i>	1.6	0.14	39.8	03

#### 4. CONCLUSIONS

The study findings suggest that all the people living in communities around Kalinzu CFR utilize the forest as a source of medicinal plant species and for other purposes. However, the use, harvesting and processing of medicinal plant species from Kalinzu forest is not sustainable. Unsustainability is due to poor harvesting methods such as debarking, stem cutting or uprooting of plants that could result into drying of part or the whole plant. Also, over-harvesting of plant parts could reduce the potential of the plants' population to regenerate and meet the increasing demands of the people.

The results identified 18 medicinal plant species belonging to 13 families and 16 genera with some plant species used in the treatment of common diseases, but their methods of preparation and applications could be similar or different, as well as the dosage administered. However, most of the herbal medicines were used in liquid form as decoctions or infusions. To a small extent, dry and powdered herbal medicines would be used externally or chewed when dry-solid. The leaves were mostly used part of the plants (42.5%) and bark (30%) and the least used part were the flowers (0.5%). Hence, the use of leaves and bark could damage the parent plant's tissues and potentials to regenerate easily.

About conservation measures, a greater proportion of the local communities living around Kalinzu forest (89%) did not practice any methods of conservation of medicinal plants, equivalent of 178 respondents interviewed of 200. Those who grow some medicinal plant species in their gardens or homes (11%) grow very few species of these plants (33.3%). Lack of conservation projects in these areas could be one of the reasons to account for this. Also, the belief by the local populations that medicinal plant species are abundant in the forest and that there is no need of growing them in gardens and homes.

#### REFERENCES

- [1] Cunningham, A. B. 1996. An Africa-wide overview of medicinal plant harvesting. Conservation and health care. FAO. Non-wood forest products, 11:16-129.
- [2] Bako, Shrestha, S. and Ssegawa, P. 2005. Ethno medicinal and Phytochemical profile of some savanna plant species in Nigeria ht. J. 144:147 -150.
- [3] World Health Organization, 2002. Traditional Medicine – growing needs and potential. WHO policy perspectives Med. 2: 1- 6.
- [4] Robins, CS. 2000. Comparative analysis of management regimes and medicinal plant trade monitoring mechanisms for America Ginseng and Goldenseal. Conserve.Biol. 14:1422 – 1434.
- [5] Kasoma, A. and Pomeroy, D.E. 1995. Useful trees and shrubs of Uganda. Swedish international development agency, Nairobi.
- [6] Maikhuri, R.K. 1998. Medicinal plants, cultivation and biosphere reserve management: A case study of Nana Deni – Biosphere reserve, Himalaya.
- [7] Govaerts, R. 2001. How many species of seed plants are there? Taxon 50:1085-1090.
- [8] Kakudidi, E.K. Z. Bukonya–Ziraba, R. Kasenene, J.M. 2000. The medicinal plants in and around Kibale N.P in western Uganda. Nor J. Bot.(Lindia) 5: 109-124.
- [9] Okello, J. and Ssegawa, P. 2007. Medicinal plants used by communities of Ngai Sub-county, Apac District, Northern Uganda, Afr. Ecol.45: 76-83.
- [10] Falconer, J. Willson, E. and Asaute, P. 1992. Non-timber forest products in Southern Ghana Draft report to ODA.
- [11] Marshall, N.T. 1997. Searching for a cure: Conservation of wildlife resources in East and South Africa. USAID and TRAFFIC Network report.
- [12] Panayotou, T. and Aston, P. S. 1992. Not by timber alone. Economics and ecology for sustaining tropical forests. Island press, Washington, USA.
- [13] Tabuti, JRS. Dhillion, S.S. and Lye, K.A. 2003(a). Traditional medicine in Bulamogi County, Uganda: Its practitioners, users and viability J. Ethno pharmacology 85: 119 – 129.
- [14] Najma – Dharani, 2002. Field guide to common trees and shrubs of East Africa. Printed by Hirt and Carter cape (pty) Ltd, capetown, South Africa.
- [15] Ticktin, T. and Johns, T. 2002. Chinateco management of *Aechmea magdala*: Implications for the use of TEK and TRM in the management plans/.Economic botany 56:177-191.

# POWER FLOW ENHANCEMENT OF 220 KV TRANSMISSION LINE WITH UNIFIED POWER FLOW CONTROLLER

Muhammad Waqas\*, Najeeb-ur-Rehman\*\*, Kashif Hussain\*, Rameez Akbar Talani\*\*\*, Jamshed A. Ansari\*

## ABSTRACT

A reliable and economical electrical power system plays a vital role in the economy of any country and its failure may seriously affect the economy. In order to achieve the reliable performance of the power system, different research techniques are being carried out. The Flexible Alternating Current Transmission System (FACTS) is a cutting edge technology and its key function is to enhance the control and power handling capability of Alternating Current (AC) transmission systems. The Unified Power Flow Controller (UPFC) is the advanced FACTS controller developed with the properties of phase shifting, voltage regulation and series compensation. It is capable of controlling the active and reactive power through a transmission lines. In this research work, the data of 220 kV transmission line has been collected and unified power controller has been designed in MATLAB/Simulink environment software to increase the reliability and performance of the transmission line. The 220 kV transmission line model has been simulated with and without UPFC in the system using MATLAB software. The simulation results of UPFC are compared to prove that this type of controller has a great impact for controlling active and reactive power of transmission line than other conventional controllers.

*Keywords: power system, alternating current, flexible ac transmission system, unified power flow controller.*

## 1. INTRODUCTION

Modern electricity supply system is invariably three-phase. The design of transmission and distribution networks is such that normal operation is reasonably close to balanced three-phase working, and often a study of the electrical conditions in one phase is sufficient to give a complete analysis [1]. A simple way of graphically representing a network is the schematic or line diagram in which three-phase circuits are represented by single lines. Transmission refers to the huge transfer of power by high voltage links between central generation and load centers. Distribution describes the dispatch of that power to the consumers by lower voltage networks [2] and [3].

In power system, the most important part is transmission system network. It acts as critical link amongst the generators and end in electricity supply [4]. Electrical power transmission systems are subjected to continuous rise of demand through-out the world and require installing new power stations. This may cause overloading of existing transmission lines and transformers. To tackle these issues, utilities may be required to erect the new transmission lines, upgrade the transformers and system components [5]. These requirements are becoming restrictive because of economic and environmental factors. Automatic control methods and devices can be employed to enhance the

system operational behavior.

Therefore, advanced and fast control components should be designed to extend the transmission capacity by utilizing installed power plants and loading transmission lines near their thermal limits even in contingency situations. Flexible Alternating Current Transmission Systems (FACTS) controllers are installed at electrical power systems for improving its performance [6].

### 1.1 Flexible Alternating Current Transmission System (FACTS)

The rising need and complex electrical power systems need efficient operation of load flow control system and keep the required load flow and improve all sort of stability [7]. The invention of power electronic components and design of control systems have made it possible for the implementation of dynamic controllers also called FACTS, which emerge as practically capable control systems for the efficient operation of the dynamic system behavior [8]. The FACTS is adopted like family of power electronic devices that have been installed to control and optimize the power flow in transmission line [9].

### 1.2 Unified Power Flow Controller (UPFC)

The most advanced FACTS controller is the Unified

\* Department of Electrical Engineering, Sukkur Institute of Business Administration, Sukkur  
Email: soomro.waqas@yahoo.com; mwaqas@iba-suk.edu.pk

\*\* National Transmission and Dispatch Company Limited, Pakistan

\*\*\* Department of Electrical Engineering, Quaid-e-Awam University of Engineering, Science and Technology, Nawabshah



Power Flow Controller. It combines three compensation properties that are phase angle, voltages and impedance, which have ability to produce a comprehensive compensation [10], [11] and [12]. It comprises of two voltage source converters; shunt and series converters that are connected with one another by dc link. Static Synchronous Series Compensator (SSSC) is installed to control the magnitude of voltage and phase angle in series with transmission line and Static Synchronous Compensator (STATCOM) is installed to control reactive power in power system, it supply dc power needed for combined inverters [13] and 14]. The branch comprises of a series transformer, shunt transformer and converters. This Vehicle Stability Control (VSC) share a common dc capacitor [15]. Its diagram is mentioned in Fig. 1.

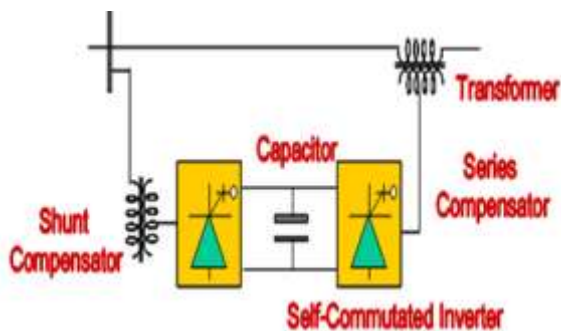

Figure-1: Unified power flow controller.

## 2. WORKING PRINCIPLE

Both voltage source inverters can operate independently with respect to one another by isolating the dc part. The shunt inverter is working as STATCOM that can control reactive power for regulating the magnitude of voltage at connection. The SSSC can control reactive power for regulating the flow of current; therefore power flow through the transmission line is controlled. UPFC possesses multiple operation modes. The shunt inverter can be operated by injecting a controlled current in transmission line. The shunt inverter is controlled with two operating modes:

### 2.1 Volt Ampere Reactive Control Mode

The reference is a capacitive or inductive Volt Ampere Reactive (VAR) setting. The control samples reference setting in to a related shunt current signal and set the inverter gate to produce required current. The necessary feedback signal representing the dc voltage  $V_{dc}$  is needed [16].

### 2.2 Automatic Voltage Control Mode

The shunt reactive current is maintained automatically for regulating the transmission line voltages at connection point to a preset quantity. Voltage feedback signal is gained from the sending end bus feeds the shunt transformer [17]. The series inverter will control the

magnitude and angle of the series injected voltage with the line to control the power flow. The injected voltages value is achieved by different methods.

**Direct Voltage Injection Mode:** The reference inputs are directly injected to phase angle and magnitude of series voltage [18].

**Phase Angle Shifter Emulation mode:** The reference input is phase displacement among sending and receiving end voltages.

**Line Impedance Emulation mode:** The reference input is an impedance preset value by inserting in series with the line impedance. [19]

**Automatic Power Flow Control Mode:** The reference inputs are preset values of active power and reactive power for maintain the parameters of transmission line irrespective of changes in system [20].

## 3. CHARACTERISTICS

The UPFC is the cutting edge power system controller and capable to provide control of magnitude of voltage; active as well as reactive power flows altogether. It possesses extended functionality, capable of voltage control, line impedance and phase angles in power system, capability of power transfer is enhanced, decrease in generation cost, improved security, stability and applicable for power flow control [21].

## 4. MATLAB SIMULATION

It is a high-level language and interactive environment for programming, simulation, and numerical analysis. We can process data, create algorithms, design models along with applications. The language, tools, and math functions helps us by exploring wide methods and achieve solutions [22]. Simulink is a block diagram environment for simulation and model based design. It supports system level design, simulation, automatic code generation, and continuous tests. Simulink has graphics editor, block function libraries, to solve for modeling and simulation of dynamic systems. It is integrated with MATLAB, enabling to incorporate MATLAB algorithms into models [23].

## 5. METHODOLOGY

In order to improve the power handling capability of a 220kV transmission line, transmission line model has been simulated in MATLAB Simulink environment to analyze the performance of transmission line before and after simulating the UPFC in the model. The technical data of a 220kV transmission line has been collected from National Transmission and Dispatch Company Limited. The performance of a transmission line with and without UPFC in the system has been analyzed. The data of 220kV transmission line has been shown in Table 1.

**Table 1: Technical data of 220kV Transmission line**

Type of conductor	RAIL
Length of transmission line	144.4 K.M
Transmission line rating	330 MVA
Current rating	880 Amperes
Voltage rating	220 K.V
Frequency	50 Hz
Resistance per KM	0.06 Ohms
Inductive reactance per KM	0.3921 Ohms
Inductance per K.M	0.0012 Henry

**6. DEVELOPMENT OF 220KV TRANSMISSION LINE MODEL**

The Simulation model in Fig. 2 is the 220 K.V transmission line model along with two loads connected mentioned as load1 and load 2. In this model pie section of transmission line have been taken in to consideration for analysis.

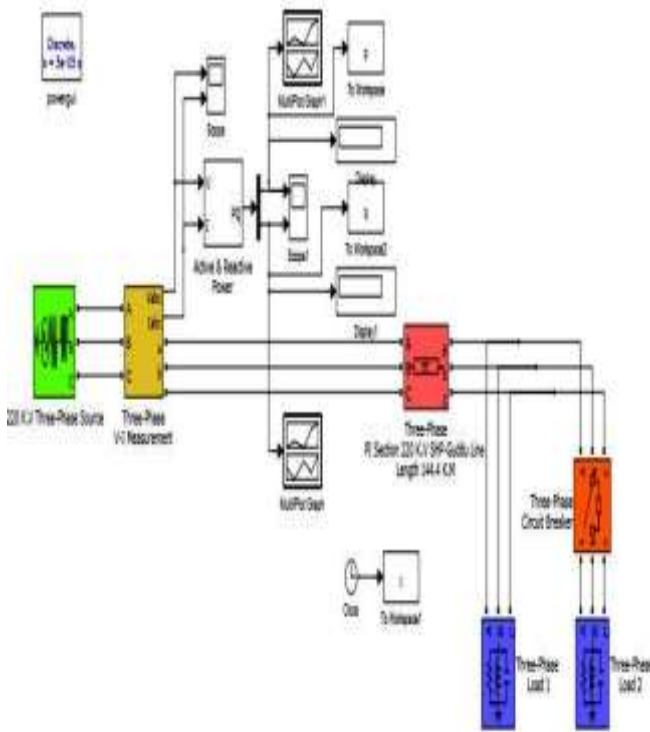

Figure-2: Simulation model of 220 K.V transmission line.

**7. DEVELOPMENT OF 220KV SHIKARPUR-GUDDU TRANSMISSION LINE MODEL WITH UPFC**

The Simulation model of 220kV transmission line along with unified power flow controller is shown in Fig. 3.

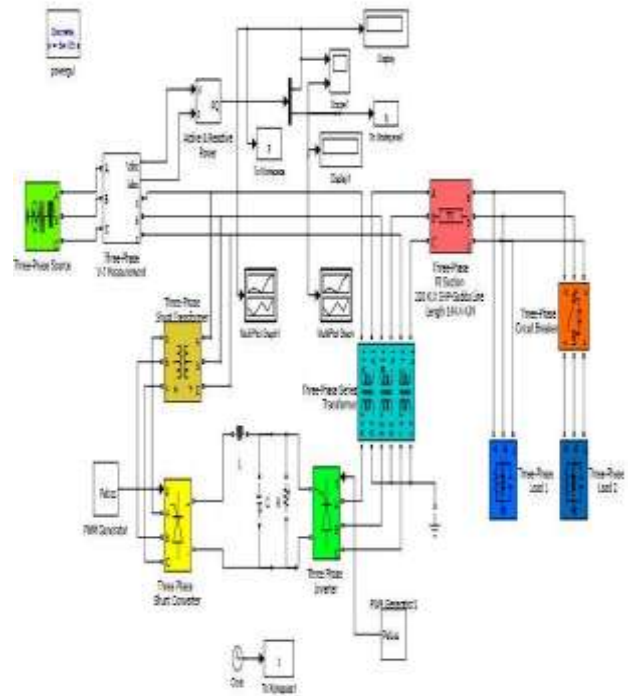

Figure-3: Simulation model of 220 K.V transmission line with UPFC.

**8. SIMULATION RESULTS**

The graphs mentioned in Figs. 4 and 5 show the waveforms of Active power and reactive power before and after implementing UPFC in the simulation model. In Fig. 4 the green color waveform is active power flow through the transmission line. The blue color waveform is active power flow through the transmission line after simulating UPFC in the system in Fig. 3.

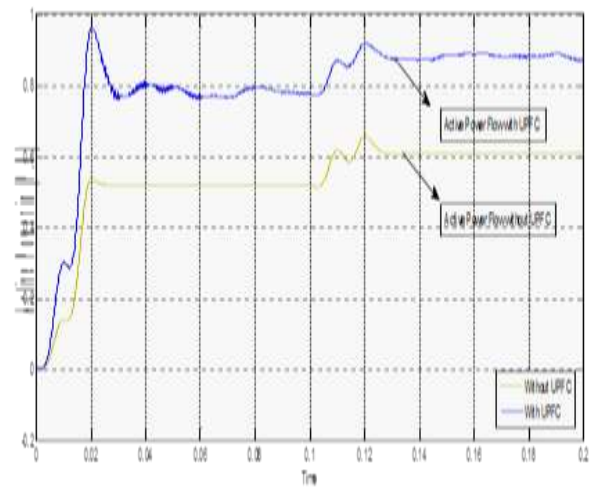

Figure-4: Waveforms of active power before & after implementing UPFC.

In Fig. 5 the red color waveform is reactive power

flowing through the transmission line while the green color waveform is reactive power flowing through the transmission line after simulating UPFC in the system in Fig. 3.

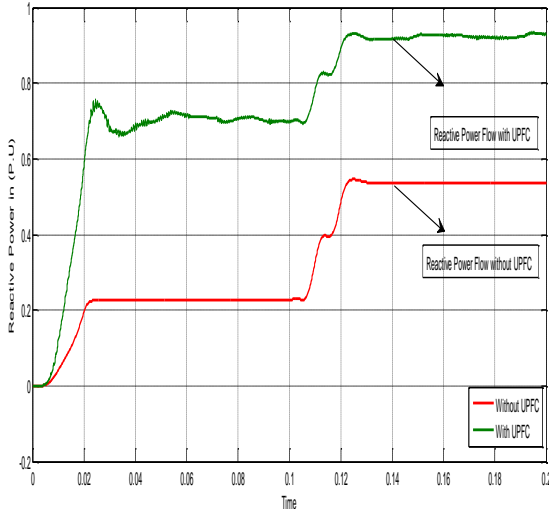

Figure-5: Waveforms of reactive power before & after implementing UPFC.

### 8.1 Comparison of Results

The results depicted in Table 2 show that the active and reactive power of 220kV transmission line is improved after implementation of UPFC based controller. The results for the active and reactive power flow of transmission line are calculated in terms of actual values as well as in p.u quantity. This proves the applicability and suitability of UPFC based controller for the transmission line.

**Table 2: Comparative analysis of results before and after implementing UPFC**

Electrical Quantities	Without UPFC		With UPFC	
	P.U	Actual Value	P.U	Actual Value
Active Power	0.61	135.8 MW	0.87	195.1 M.W
Reactive Power	0.54	119.7 Mvar	0.92	207 Mvar

### 8.2 Graphical Representation of Results

Fig. 6 shows the graphical representation of simulation results for active and reactive power flow of the transmission line. The results for active and reactive power for transmission line are simulated with and without UPFC based controller and are then compared graphically in terms of per unit values. The improved p.u values with UPFC based controller clearly state its applicability.

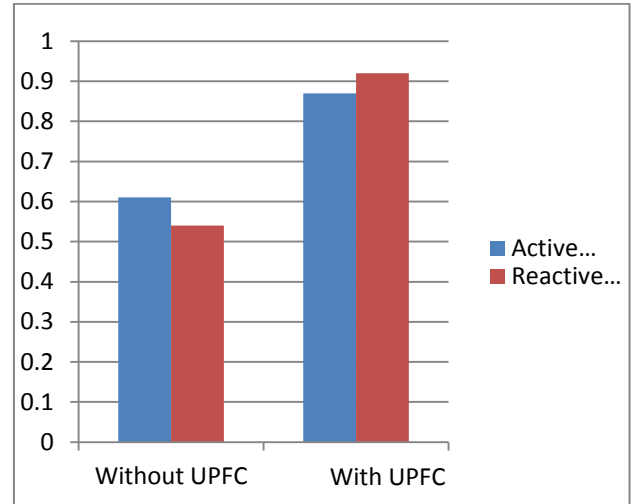

Figure-6: Graphical representation of results.

## 9. CONCLUSION

After simulating the UPFC, the load flow through the 220kV transmission has been improved. Active power through the system has been enhanced. As power flow is enhanced so the per unit cost will also be reduced. Existing transmission lines can be used at an extending capacity thereby reduced the economic burden of newly erected transmission lines. Technical losses through the transmission line are reduced. Therefore, the overall performance of a transmission line is improved.

## REFERENCES

- [1] Weedy B.M, Cory B.J, Jenkins N, Ekanayake J.B, Strbac G, "Electric Power Systems" 5<sup>th</sup> Edition 2012, John Wiley & Sons Ltd, ISBN 9780470682685, pp 27-30.
- [2] Hadi Saadat, "Power System Analysis" McGraw-Hill companies, ISBN No. 0-07-561634-3, pp 142-152.
- [3] Ackermann T, "Wind Power in Power Systems" Edition 2005, John Wiley & Sons, Ltd, ISBN: 0-470-85508-8, pp 434-435.
- [4] Chengaiah Ch and Satyanarayana R.V.S, "Power flow Assessment in Transmission Line using Simulink Model with UPFC" ISSN 978-1-4673-0210-4, (2012), pp 151-155.
- [5] Shuitao Yang, Yang Liu, Xiapru Wang and Gunasekaran, "Modulation and Control of Transformer less UPFC", IEEE Transaction on Power Electronics, Vol. 31 , Issue No.2 , March 2015, pp 1050-1063.
- [6] Omar H. Abdalla, Mohammed A. E. Ghazy, Lotfy M. Lotfy and Nermeen A. M. Hassan, "Unified Power Flow Controller with Decoupled State Feedback" Proceedings of the 14<sup>th</sup> International Middle East Power Systems Conference (MEPCON'10), Cairo University, Egypt, 19-21 December 2010, Paper ID 307, pp 920-925.
- [7] Naveen Kumar Reddy B. M, Rajashekar G. V, Himani Goyal, "Power System Stability Enhancement using

- Static Synchronous Series Compensator (SSSC)", International Journal of Modern Engineering Research (IJMER), Vol. 3, Issue. 4, Jul - Aug. 2013, ISSN: 2249-6645, pp 2530-2536.
- [8] Baskar S, Kumarappan N and Gnanadass R, "Switching Level Modeling and Operation of Unified Power Flow Controller" Asian Power Electronics Journal, Vol. 4, No.3 December 2010, pp 109-115.
- [9] Bindeshwar Singh, Verma K.S, Deependra Singh, Singh C.N, Archana Singh, Ekta Agrawal, Rahul Dixit and Baljiv Tyagi, "Introduction to Facts Controllers a Critical Review", International Journal of Reviews in Computing, 31<sup>st</sup> December 2011, Vol. 8, ISSN: 2076-3328, pp 17-34.
- [10] Ray A. and Chandle J. O, "Voltage Stability Enhancement During Excess Load Increments through Optimal Location of UPFC Devices" IEEE Conference Proceedings on Advancements in Power and Energy (TAP Energy), June 2015, pp 443-448.
- [11] Ch. Kiran Kumar, Sudheer Kumar M, SriramBabu V and Nagulmeera S, "A Comparative Analysis of UPFC as a Power Flow Controller with Applications" IOSR Journal of Electrical and Electronics Engineering, Volume 4, Issue No. 6, March - April 2013, e-ISSN: 2278-1676, pp 53-61.
- [12] Nitin goel, Shilpa and Shashi Yadav, "Simulation of Real and Reactive Power Flow Assessment with UPFC Connected to a Single/Double Transmission Line", International Journal of Advanced Research in Electrical, Electronics and Instrumentation Engineering, ISSN (Print) : 2320 – 3765, ISSN (Online): 2278 – 8875, Vol. 3, Issue No. 4, April 2014, pp 8384-8491.
- [13] Pranesh Rao, "STATCOM Control for Power System Voltage Control Applications", IEEE Transactions On Power Delivery, Vol. 15, Issue No. 4, October 2000, pp 1311-1317.
- [14] Muruganandham J, Arun K, Thangaraj K and Malarselvam V, "Performance Analysis of Interline Unified Power Flow Controller for Parallel Transmission Lines", IEEE International Conference Proceedings on Electrical, Computer and Communication Technologies (ICECCT), March 2015, pp 1-8.
- [15] Nashiren F. Mailah, Senan M. Bashi , "Single Phase Unified Power Flow Controller (UPFC): Simulation and Construction" European Journal of Scientific Research, ISSN 1450-216X, Vol. 30, Issue No.4 (2009), pp 677-684.
- [16] Karthigevan P, Raja M. S, Sheeba M. S and Gnanaselvam R, "Optimization of Power Quality Problem for a Wind Turbine Fixed Speed Induction Generator Under Asymmetric Faults Using UPFC Fed Vector Control-PI Hysteresis and Fuzzy Logic", IEEE 2<sup>nd</sup> International Conference Proceedings on Electronics and Communication Systems (ICECS), Feb 2015, pp 568-571.
- [17] Gupta K, Khan B. and Mubeen S. E, "Available Transfer Capability Enhancement by Unified Power Flow Controller", IEEE International Conference Proceedings on Signal Processing, Information, Communication and Energy Systems (SPICES), February 2015, pp 1-4.
- [18] Usha A.P. Rani and Rama Reddy B. S, "Modeling and Digital Simulation of Interline Power Flow Controller System" International Journal of Computer and Electrical Engineering, Vol. 2, Issue No. 3, June 2010, ISSN 1793-816, pp 441-446.
- [19] Bindeshwar Singh, Verma K.S, Pooja Mishra, Rashi Maheshwari and Utkarsha Srivastave, "Introduction to FACTS Controllers: A Technological Literature survey", International journal of Automation and Power Engineering, Vol. 1, Issue No. 9, December 2012, pp 193-234.
- [20] Tara Kalyani S and Tulasiram Das G, "Simulation of Real and Reactive Power Flow Control with UPFC Connected to a Transmission Line" Journal of Theoretical and Applied Information Technology 2008, pp 16-22.
- [21] Prabha Kundur, "Power System Stability & Control", McGraw-Hill companies, ISBN: 007035958, pp 639.
- [22] "MATLAB Primer R2014b", Mathworks, pp 1-2.
- [23] "Simulink Getting Started guide" Mathworks, pp1-2.

# ALL-RE: A MODEL FOR TEACHING AND LEARNING REQUIREMENTS ENGINEERING

Rafia Naz Memon\*, Irfana Memon\*\*, Shah Zaman Nizamani\*, Fiza Siyal\*, Pardeep Kumar\*\*

## ABSTRACT

Requirements Engineering (RE) is an uncertain discipline and requires comprehensive understanding from the organizational, human and technical aspects. Therefore a suitable and adaptive approach is needed to teach RE. This paper aims to analyze the student's and lecturer's perceptions and understanding of RE and propose a learning model that can be adopted and employed to teach RE course. Through literature review and surveys, the student's and lecturer's perceptions and understanding of RE were analyzed that lead us to the need of a collaborative and sustainable learning model for teaching RE course. A learning model based on activity-Led learning (a pedagogical approach that uses activity as a main point of learning experience) was proposed for teaching RE. The proposed model was named as ALL-RE to depict that the model is based on activity-Led learning (ALL) and intended to be used for teaching and learning requirements engineering (ALL-RE). The main ideas of ALL-RE model is the inclusion of teaching and learning material (in the form of RE course material, knowledge repository and case studies) and various teaching, learning and assessment methods. ALL-RE was then evaluated through expert reviews by the RE experts and showed positive results.

*Keywords: Requirements Engineering, Requirements Engineering Education, Activity-Led learning, didactic triangle.*

## 1 INTRODUCTION

Requirements Engineering (RE) is considered as one of the most complex discipline of software engineering. [1] Due to its complex and uncertain nature, it requires comprehensive understanding of organizational, human and technical aspects of users and systems. The future software/requirements engineers will get in depth knowledge of RE only when they are taught RE as a core course in universities using rigorous teaching methods. However as evident by RE literature, the RE course offering in universities have several deficiencies. The problems that students and lecturers face in studying and teaching RE course are reported in several studies such as [2-6] etc. Due to the deficiency of RE course offerings in universities, software developers have to learn to perform RE while doing their jobs [7]. This makes most software developers lacking in RE skills and knowledge. Therefore it is suggested that a suitable and adoptive approach is needed to teach RE course that can provide students sufficient RE skills and prepare them for working on industrial projects.

This study therefore aims to analyze the student's and lecturer's perceptions and understanding of RE and to propose a learning model that can be adopted and employed to teach RE course to software engineering students in a traditional academic environment in universities. The proposed model can also be used to teach RE in industry led and open delivery courses and

certifications. Through literature review and surveys, the student's and lecturer's perceptions and understanding of RE are analyzed using edges of didactic triangle proposed by [8]. This analysis results lead us to the need of a collaborative and sustainable learning model for teaching RE course. A learning model based on activity-led learning (a pedagogical approach which uses activity as a focal point of learning experience) is then proposed. The proposed model was named as ALL-RE to depict that the model is based on activity-Led learning (ALL) and intended to be used for teaching and learning requirements engineering (ALL-RE). The main ideas of ALL-RE model is the inclusion of iterative process of learning, the knowledge repository that keep past examples, the ability to retrieve related example projects, and the ability to share and get feedback from others in the class. ALL-RE was then evaluated through expert reviews by RE experts (the lecturers who have experience of teaching and researchers who are doing research on RE).

The rest of paper is organized as follows. Section 2 presents the student's and teacher's perceptions and understanding of RE course through edges of didactic triangle, section 3 elaborates the need of a learning model for teaching RE course, section 4 presents the proposed learning model (ALL-RE) and explains its components, section 5 presents the evaluation of ALL-RE model and section 6 summarizes and concludes the paper.

\* Department of Information Technology, QUEST, Pakistan  
{rafia@quest.edu.pk}

\*\* Department of Computer Systems Engineering, QUEST, Pakistan



## 2 THE DIDACTIC TRIANGLE

An effective way to analyze and describe the teaching situation of the subject is through three main elements: the student, the teacher and the content [9]. The didactic triangle by Kansanen [8] effectively illustrates these elements and their interaction. The triangle is used as an analytical tool for analyzing and improving awareness of the current status of the subject (RE in our case) [9]. Kansanen's didactic triangle is presented in Fig. 1 below.

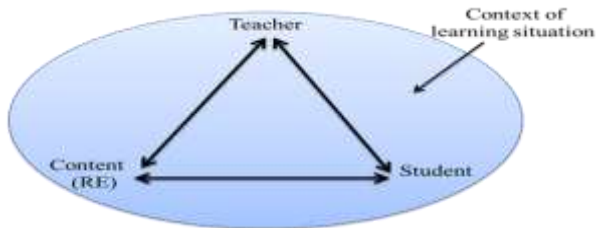

Figure-1 The didactic triangle

In this study, teaching and learning situation of RE course is analyzed using edges of didactic triangle that are: RE and teachers, RE and students, and student and teacher. The following sub sections discuss each of them.

### 2.1 RE and Teachers

In the relation between the teacher and the content, the teacher's competence in content is in focus [8]. The relationship between teachers and RE is analysed to find out the teacher's perception and understanding of RE. Most of the authors of studies related to Requirements Engineering Education (REE) are lecturers teaching RE course. They have shared their experiences of teaching RE and presented problems they encountered in teaching RE. Our analysis based on the related literature review and the survey results performed on lecturers [5] lead us to the following observations:

- The commonly used RE teaching methods are lectures, whereas a few other approaches used are labs, group discussions and presentations.
- Most of the basic RE concepts are taught in RE course, while RE challenges are not emphasized due to the lack of practical work. Lecturers feel that it is difficult for them to set practical exercises for students in class.
- Teachers have not given sufficient time period to cover RE (normally they have to complete the course in about 3-4 months), while the advanced RE topics are not covered by the syllabus provided to them by the course designers.
- Lecturers face difficulty in teaching students to deal with RE challenges such as changing requirements.
- According to lecturers, teaching students to communicate with original customers need a lot of resources not usually available at institutions.

- Lecturers feel it difficult to find the good case studies and proper RE tools to be used for teaching RE.
- Many researchers have provided solutions to resolve REE problems and improve REE, however REE community still report many problems.

Based on the above observations, it can be concluded that lecturers are ready to offer practical experience to students by giving them practical examples, and assigning and involving them in lab exercises, but they are unable to do so due to the lack of proper course materials, resources and advanced teaching methods.

### 2.2 RE and Students

The student's relationship to the RE is the key to didactic understanding [8]. The relationship between students and RE is analyzed to find out the student's perception and understanding of RE. Our analysis based on related literature review and results of surveys performed on students [2, 10] lead us to the following observations.

- The students are mostly learnt RE through lectures, presentations and group discussions. Only few have exposure of lab exercises.
- They find requirements modelling and analysis as the most difficult RE activity to perform.
- Mostly students taking RE course have no industrial experience neither they have provided any while teaching RE course but only been exposed to small and toy projects.
- The students have been taught basic RE concepts but dealing with RE challenges and RE process models are not emphasized in class.
- Students need group projects and independent exercises as assessment methods.
- Students found RE course hard to understand and boring due to strong emphasis on theoretical parts rather than practical side.
- Students have difficulty in applying knowledge of RE in the real world.

Based on above observations, it can be concluded that students need improved teaching approaches that can introduce exercises, real-life examples of industrial projects, more interesting ways to deliver lectures, reduce theoretical parts and include tools to perform RE activities in practice. In addition, they need enhanced assessment methods such as group assessment.

### 2.3 Teachers and Students

The relationship between teachers and students is a neglected area of REE research. The teacher-student relationship is a two-way but REE literature does not write more on this relationship. In general, a few reporting from literature are presented here.



A focus group study was conducted with teachers by [11]. One focus group participant stated about the emotional connection with students as... If you want to be a good teacher, you really have to show the students ... that you are passionate about the things you are teaching. The students can very quickly discover the fraud, so you must actually show your love of that material, if that comes across I think half the battle is won. [12] argued that the student-centered approach is more advanced and effective, in that it presupposes the teacher-centered approach. To focus on the student, a teacher must be capable of taking a step 'outside' herself and seeing her acts not as an aim in itself, but in relation to the student.

Based on this analysis, it can be concluded that the attitude of teachers is an important factor. RE course should be taught using student-centered approach in which teachers should not only teach students through the usual role of informer, but also collaborate with students by using various teaching methods and by playing different roles.

### 3 THE NEED OF A LEARNING MODEL

The information about existing REE literature and state-of-art concepts is presented in our previous work. Such as complete analysis of all REE problems reported in literature is presented in a conceptual integrated model [6], verification of REE problems through empirical studies from lecturers is presented in [5] and from students is presented in [10], recommendations for improving REE are presented through a direction framework in [10], and critical issues in REE are presented in [13].

It is observed that RE process as presented in the books and literature and as it is being taught in institutions are not according to the needs of industry [14]. Students and teachers are facing number of problems in learning and teaching RE course. This is due to the fact that students are still taught RE through traditional methods. It is therefore recommended that software engineering education should introduce alternative teaching approaches. [15] Thus, there is a need of improved teaching and learning approach to include learner-centered design while developing curriculum and teaching methods, to exploit new technologies for on-campus learning [16].

Based on the analysis of didactic relationships, an approach for teaching RE is needed that can:

- Incorporate practical experience
- Use real projects
- Assign lab exercises
- Include real-life examples of industrial projects
- Include tools to perform RE activities
- Reduce theoretical parts

- Use student-centered approach
- Include enhanced assessment methods
- Actively involve students in a learning process.

The student-centered teaching approach can be developed in the form of a learning model. McCowan and Knapper point out: "Learning is a passive system has a much greater tendency to be both superficial and quickly forgotten. Active involvement in learning helps the student to develop the skills of self-learning while at the same time contributing to a deeper, longer lasting knowledge of the theoretical material...[and]...it is almost the only effective way to develop professional skills and to realize the integration of material from different sources" [17]

A learning model based on Activity-Led Learning (ALL) was therefore proposed in order to actively involve students in a learning process. ALL was selected because it is a learning approach that emphasizes on promoting student retention, engagement and achievement, and hence can serve the aim of this study. The proposed learning model is described in the following section.

### 4 A PROPOSED LEARNING MODEL

This section first introduces ALL approach and then presents the proposed learning model in detail.

#### 4.1 Activity Led Learning (ALL)

The ALL approach was proposed by Coventry University, UK to improve the learning experience of students and address the problem of student satisfaction and retention rates. ALL is a pedagogic approach in which the activity is the focal point of the learning experience and the tutor acts as a facilitator. An activity is a problem, project, scenario, case-study, research question or similar in a class room, work-based, laboratory-based or other appropriate setting and for which a range of solutions or responses are appropriate [18]. ALL needs an independent process in which the individual learner, or team of learners, get and apply the information, practices, personal and physical resources related to the task or activity being performed [19].

#### 4.2 ALL-RE: A learning model based on ALL

A learning model was proposed that applies ALL to RE course (and therefore named as ALL-RE). Through ALL approach, the students acquire technical skills as well as some business knowledge and practice some of their soft skills on real-life situations [20]. The ALL-RE model also includes the material to help lecturers and students in teaching and learning RE. The proposed ALL-RE learning model is presented in Fig. 2. The components of the ALL-RE model are explained in detail below.

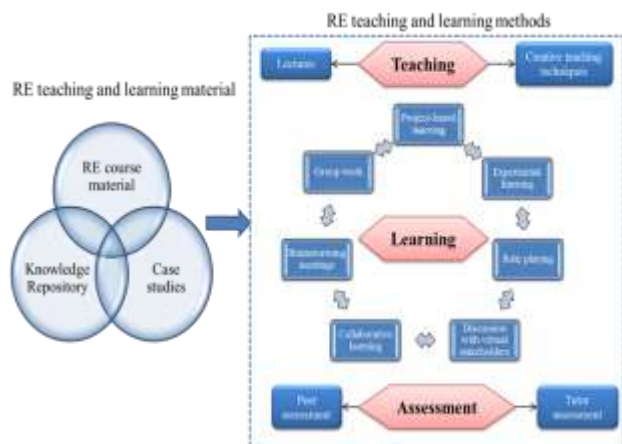

Figure-2 The ALL-RE learning model

RE teaching and learning material. The suitable and appropriate material plays an important role in the learning process. It is suggested that during RE course, the lecturers should strive to provide students with the following items.

RE course material. RE course should be designed according to guidelines provided by software engineering community in “Guide to Software Engineering body of knowledge” [21]. In addition, a report entitled “Software Engineering 2004 – Curriculum Guidelines for Undergraduate Degree Programs in Software Engineering” [15] by ACM and IEEE education board recommended software engineering core curriculum and a section entitled “Software Modelling and Analysis” includes the complete core RE curriculum. The course designers should consider this core curriculum as a basis to design RE courses for their universities. They can also enhance and include advance topics depending on their program structure and available resources. During RE course delivery, the lecturers should provide complete RE course contents along with the reference material to students to help them in their learning process.

Knowledge Repository. Because of its theoretical nature, the students take less interest in RE and easily forget the important concepts. Therefore it becomes very difficult for them to deploy those concepts for performing RE activities. To address this problem, the idea of creating RE knowledge repository is proposed. The knowledge repository should keep all RE concepts with example projects from industry, past examples solved by students, solved case studies, sample software requirements specifications (i.e. the final output of RE process) and any other information that can help students in their learning process. The students should be able to retrieve any required information from the knowledge repository. The lecturers should create the knowledge repository and provide it to students during RE course.

Case studies. The students should be provided with the list of unsolved case studies. Lecturer should make the groups of 4-5 students and assign each group a case study to solve. The students can take help from knowledge repository by retrieving solved case studies and example projects, and can make use of various learning methods to solve the case studies.

RE teaching and learning methods. The teaching and learning methods are based on ALL’s teaching, learning and assessment methodology. To enhance students’ understanding and to provide them guidance in their learning process, the following teaching and learning methods should be used.

Teaching. The lecturer plays the role of tutor as well as facilitator. In a traditional role of tutor, the lecturers deliver their lectures according to predefined schedule. While as a facilitator, the lecturer plays multiple roles. Such as provide RE teaching and learning material (including RE course material, knowledge repository and case studies), facilitate students in the various learning methods (e.g. play the role of virtual stakeholder) etc. The teaching includes:

- **Lectures**

The lecturers deliver lectures in a typical class room environment to provide students the background knowledge and basic RE concepts.

- **Creative teaching techniques**

The lecturer should always strive for using innovative and creative teaching technique along with lectures to make it easier for students to understand the complex and theoretical subject like RE. In order to make class experience of students interesting, creative teaching applies flexible and appropriate techniques. Creative teaching emphasized that the lecturers should be sharers of knowledge as well as inspirers and navigators [22].

Lecturer should adopt various creative teaching techniques based on subject matter, teaching resources, their teaching style and personality influence. Few examples of creative teaching techniques are: picture prompt (showing students an image without any explanation and ask them to explain it and justify their answers, instructor storytelling (Instructor illustrates a concept, idea, or principle with real-life application, model, or case-study), empty outlines (distribute a partially completed outline of today’s lecture and ask students to fill it in at the start or at the end of class) [23].

Learning. As proposed by our model, learning RE is achieved through the iterative process of learning various methods. These methods are successfully adopted by various researchers. The various learning methods are presented below.

- **Project-based learning**

Project-based learning engages students as active learners by assigning them RE projects. Students experience and learn to perform RE activities by applying them on their projects. This method of learning has been emphasized and adopted by [24]. Through project-based learning they tend to provide in depth knowledge of RE to students and improve the collaboration.

- **Group work**

Group work is a valuable experience for students that provide them a better opportunity for learning many RE topics as well as practicing the theoretical issues [25]. By forming the groups of students and assigning them RE tasks, students are encouraged to hold group discussions and performing group exercises. Learning through group work is successfully adopted by [25-27].

- **Brainstorming meetings**

Brainstorming is the process of systematic and liberal generation of a large volume of creative ideas from a number of participants [28]. Typical brainstorming meetings in RE course can bring students together into a creative process through which the students can effectively learn RE concepts. Learning through brainstorming is successfully adopted by [3].

- **Collaborative learning**

Learning through collaborative activities aims to provide students with RE skills by interacting with stakeholders who have different needs and requirements. Our aim of introducing collaborative activities in RE course is to emulate an experience that students are likely to be engaged in as practicing requirements engineers [29]. Learning through collaborative activities has successfully been adopted by [29, 30].

- **Discussion with virtual stakeholder:**

Incorporating virtual stakeholder in RE course project and learning through discussing with virtual stakeholder can be an effective learning method to help students in learning RE concepts and can improve students' communication skills. The lecturers, supporting staff or non-software engineering students can play the role of virtual stakeholder. Learning through discussion with virtual stakeholder has successfully been adopted by [31].

- **Role playing:**

Role playing is an effective and widely used technique for teaching RE course [32]. The students can actively participate in their learning by playing different roles such as client and developer. Learning RE through role playing has successfully been adopted by several researchers that are [26, 33-35].

- **Experiential learning:**

The experiential learning method provides students organizational experience in RE course by giving them an opportunity to experience a simulated work environment. Using this method, the students can learn RE practices by playing the educational games that simulate a business case and then discuss the problems faced in the game. The experiential learning approach in teaching RE course has successfully been adopted by [4, 36].

A few other methods that can help students in learning RE are just-in-time learning (teaching fundamental material immediately before teaching the application of that material), learning by failure (Students are given a very difficult task and then taught methods that would enable them in future to do the tasks more easily and self-study materials (Students work through their own schedule, it include online and computer-based learning) [37].

Assessment. The assessment should be performed in a way that promote integration of assessment and instruction, seeing the student as an active person who shares responsibility, reflects, collaborates and conducts a continuous dialogue with the teacher [38]. In RE course, two assessment methods are suggested to be included in order to help students in their learning process that are peer assessment and tutor assessment.

- **Peer assessment**

Peer assessment is the process through which groups of individuals rate their peers [39]. Peer assessment may be in the form of informal feedback from group members or it may involve the use of rating instruments designed by lecturers or group heads before the peer assessment exercise. The peer assessment method is suggested and adopted by [20, 35] in their studies.

- **Tutor assessment**

This is the normal form of assessment carried out at universities. However the suggested way of carrying out this method of assessment is bit different. Tutor assessment is carried out by lecturer who examines the documentation developed by each group in response to the tasks and projects assigned to them. There should be an assessed seminar in which groups of students discuss their solutions and the lecturer observes the quality of their discussions. At the end of seminar, the lecturer highlights the strengths and weaknesses of their solutions and provides feedback on the performance of students.

## 5 EVALUATION OF ALL-RE

The proposed ALL-RE model was evaluated using expert reviews. This evaluation study aimed at evaluating the effectiveness of ALL-RE model for teaching and learning RE course in universities. This section presents the

evaluation study in terms of participants, questionnaire, procedure used and results.

### 5.1 PARTICIPANTS

The target participants of this study were the lecturers experienced in teaching RE and the researchers doing

research in RE. They can be considered RE experts because of their experience and knowledge in RE and it was expected that they can better respond to questionnaire. A total of 7 experts participated voluntarily in the study in response to an invitation by email. A brief profile of participants in presented in Table 1.

**Table 1- Profile of the participants of evaluation study**

No.	Position	Institution	Experience in years
01	Associate professor	Quaid-e-Awam university of Engineering, Science & Technology, Pakistan	12
02	Researcher	University of Malaya, Malaysia	05
03	Senior lecturer	University of Malaya, Malaysia	10
04	Assistant professor	Isra University, Pakistan	10
05	Assistant professor	Quaid-e-Awam university of Engineering, Science & Technology, Pakistan	07
06	Researcher	Mehran university of Engineering & Technology, Pakistan	06+
07	Researcher	Hanyang University, ERICA Campus, South Korea	06

### 5.2 Questionnaire

The questionnaire consists of following parts.

- In the first part of questionnaire, participants were asked their opinion about the importance of the elements related to RE teaching and learning material used in the model with the scale 5 (Most important) - 1 (Least important).
- In the second part of questionnaire, participants were asked their opinion about the importance of the elements related to RE teaching and learning methods used in the model with the scale 5 (Most important) - 1 (Least important).
- In the third part of questionnaire, the participant were asked their opinion about the possibility to provide the material and use the methods proposed in the model within the limited time and resources available at universities for teaching RE course. The scale used was 3 (Possible) - 1 (Not possible).
- In the fourth part of questionnaire, the participants were asked to rate the following in order to assess the effectiveness of the model with the scale 1 (Strongly agree) – 5 (Strongly disagree).
- The concepts used in the model are relevant to RE.
- The teaching and learning material and methods (if used in teaching) can help in addressing RE problems.
- The students will be able to understand RE well if proposed model is implemented.
- Overall the model (if implemented) is effective to address RE problems and teach RE course.

- Your suggestions for improving the framework (if any).

### 5.3 Procedure

The background material and details of the model along with the questionnaire were sent to participants through email and they were requested to go through the material and fill in the questionnaires.

### 5.4 Results

The results of each part of questionnaire is presented and discussed below.

#### 5.4.1 Results from part 1 of questionnaire

The results obtained from the rating of the importance of the RE teaching and learning material elements used in the model are presented in the Fig. 3.

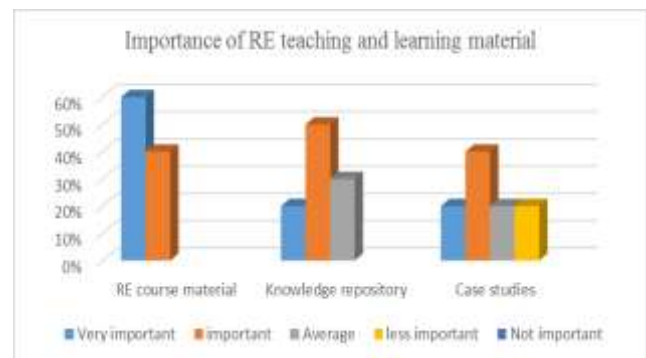

Figure-3 The ratings on importance of RE teaching and learning material

The results show that most of the experts feel the material used in the model as most important and important. Only few think the knowledge repository and case studies as average or less important. Hence, based on expert's opinions, the material used in the model can be considered acceptable.

#### 5.4.2 Results from part 2 of questionnaire

The results obtained from the rating of the importance of the RE teaching and learning method elements used in the model are presented in Fig. 4.

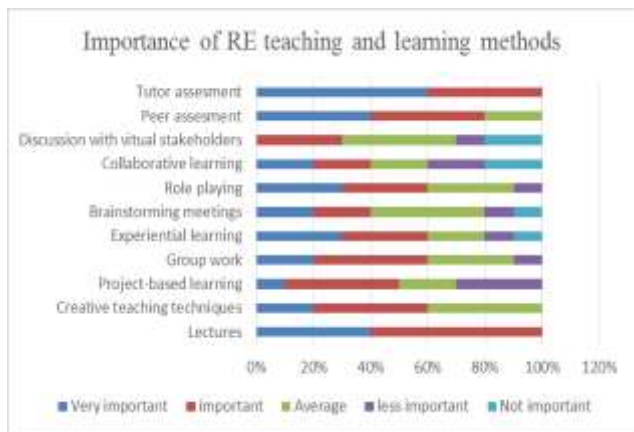

Figure- 4 The ratings on importance of RE teaching and learning material

The results show that according to experts, RE teaching and learning methods used in model are mostly important to be used in class rooms for teaching RE. Only few such as, discussion with virtual stakeholders, collaborative learning and experiential learning can be considered either less important or not important.

#### 5.4.3 Results from part 3 of questionnaire

The results obtained from the rating of the possibility to provide the material and use the methods proposed in the model within the limited time and resources available at universities for teaching RE course are presented in Fig. 5.

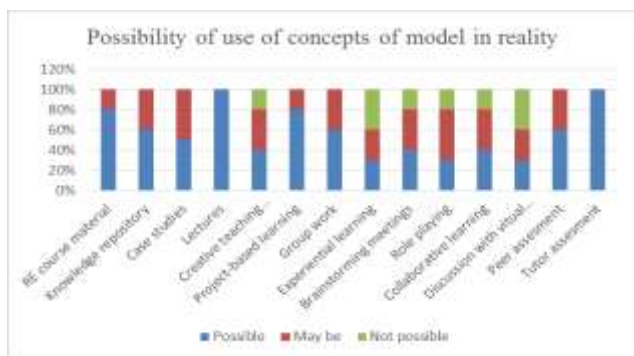

Figure-5 The possibility to use the material and methods proposed in model in RE course

The results show that according to experts, few teaching methods may not be possible to use in real class rooms such as creative teaching techniques, experiential learning, role playing, collaborative learning, discussion with virtual stakeholders etc. The possible reason can be the need of more time and resources in implementing such techniques. While the other well-known methods are possible to implement in class rooms.

#### 5.4.4 Results from part 4 of questionnaire

The results obtained from the assessment of the effectiveness of the model is presented in Fig. 6.

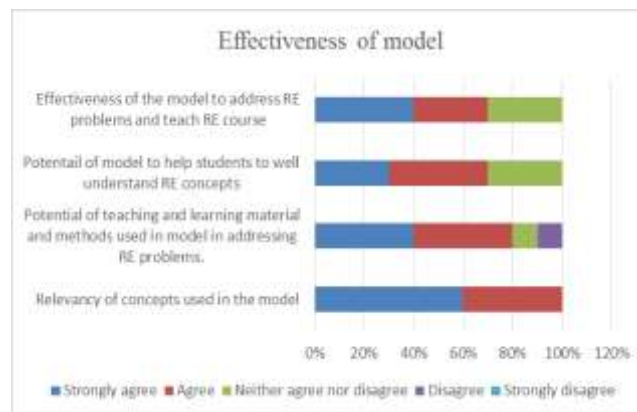

Figure-6 The ratings on effectiveness of model

The results show that the model can be considered effective based to experts' opinions. However, while giving suggestions, experts mentioned that the actual applicability and effectiveness of the model can be measured by implementing it in universities for teaching RE course.

#### 5.4 Threats to validity

To ensure representative coverage, our subjects included lecturers and researchers of various levels of experiences, qualifications and backgrounds.

Clearly, an important limitation of the evaluation study involves the small sample size (only 7) and the relatively homogenous population (lecturers and researchers from three Asian countries). This severely limits the external validity of this study.

Fortunately, the goal of this study is to evaluate the learning model proposed for teaching RE. Because of the factors that the RE course is being taught using standard topics and due to the nature of RE, students and lecturers usually face similar problems in learning RE concepts. Therefore, it is expected that a replication of this study in a different site and/or with different size teams shall generate the same results. However, all the lecturers and researchers participated in the study are either involved in teaching RE course or in doing research in RE in different countries. Therefore the results can be generalized.

## 6 SUMMARY AND CONCLUSION

The paper analyses the status of teaching and learning RE course through the relationships depicted by edges of didactic triangle. The literature review of REE and the surveys performed on lecturers and students acted as the background of the analysis. The analyses results lead us to the need of a learning model for teaching RE that can improve the lacking in current teaching and assessment methods. A learning model named ALL-RE based on Activity-Led Learning (ALL) was then proposed to involve students as active learners by performing various activities and to involve lecturers as a facilitator by playing different roles. The proposed learning model includes teaching and learning materials as well as teaching and learning methods. It is suggested to include RE course material, knowledge repository and case studies in the teaching and learning material. While teaching and learning methods follow ALL's approach by including its three main elements that are teaching, learning and assessment. Teaching includes two methods that are lectures and creative teaching techniques. Learning includes an iterative cycle of various methods to emphasize more on learning at every stage of the course. While assessment include two methods that are peer assessment and tutor assessment. Therefore it can be said that the proposed model describes the way of improving teaching methods for learning RE course. The preliminary evaluation of ALL-RE was performed through expert's reviews which showed positive results; however it is desired to validate the model by implementing it in universities for teaching RE course.

It is supposed that proposed model will help the production of quality requirements engineers that possess RE skills. It can provide great support towards developing the right system with the right requirements for users. Also the proposed model, with some refinements, can be applied to any course relevant to software engineering discipline.

## REFERENCES

- [1] Berenbach, B., et al., *Software & systems requirements engineering: in practice*. 2009: McGraw-Hill, Inc.
- [2] Memon, R.N., R. Ahmad, and S.S. Salim. Problems in requirements engineering education: a survey. in *FIT '10*. 2010. Pakistan: ACM.
- [3] Barnes, R.J., D.C. Gause, and E.C. Way. Teaching the Unknown and the Unknowable in Requirements Engineering Education. in *Requirements Engineering Education and Training*. 2008. IEEE.
- [4] Regev, G., D.C. Gause, and A. Wegmann, *Experiential learning approach for requirements engineering education*. *Requirements Engineering*, 2009. 14(4): p. 269-287.
- [5] Memon, R.N., S.S. Salim, and R. Ahmad, *Identifying Research Gaps in Requirements Engineering Education: An Analysis of a Conceptual Model and Survey Results*, in *IEEE Conference on Open Systems 2012*. 2012: Kuala Lumpur, Malaysia.
- [6] Memon, R.N., S.S. Salim, and R. Ahmad, *Analysis and classification of problems associated with requirements engineering education: Towards an integrated view*. *Arabian Journal for science and Engineering*, 2013. 39(3): p. 1923-1935.
- [7] Jiang, L., A. Eberlein, and B.H. Far. Combining Requirements Engineering Techniques—Theory and Case Study. in *12th IEEE International Conference and Workshops on the Engineering of Computer-Based Systems (ECBS'05)*. 2005. IEEE.
- [8] Kansanen, P. and M. Meri, *The didactic relation in the teaching-studying-learning process*. *Didaktik/Fachdidaktik as Science (-s) of the Teaching profession*, 1999. 2(1): p. 107-116.
- [9] Berglund, A. and R. Lister. *Introductory Programming and the Didactic Triangle*. in *Proc. 12th Australasian Computing Education Conference (ACE 2010)*. 2010. Brisbane, Australia.
- [10] Memon, R.N., R. Ahmad, and S.S. Salim, *Requirements Engineering Education (REE): Problems and Recommendations for RE course implementations*. *Malaysian Journal of Computer Science*, 2013. 26(4): p. 294-311.
- [11] Kutay, C. and R. Lister. *Up close and pedagogical: computing academics talk about teaching*. in *Proceedings of the 8th Australasian Conference on Computing Education-Volume 52*. 2006. Australian Computer Society, Inc.
- [12] Kember, D., *A reconceptualisation of the research into university academics' conceptions of teaching*. *Learning and instruction*, 1997. 7(3): p. 255-275.
- [13] Memon, R.N., R. Ahmad, and S.S. Salim, *Critical Issues in Requirements Engineering Education*, in *State-of-the-Art Concepts and Future Directions in Software Engineering*. 2014, IGI Global.
- [14] Nguyen, L., J. Armarego, and P. Swatman, *Understanding Requirements Engineering: a Challenge for Practice and Education*. *School Working Papers Series 2002*, 2002.
- [15] LeBlanc, R., et al., *Software engineering 2004: curriculum guidelines for undergraduate degree programs in software engineering*, in *ACM/IEEE-CS Joint Task Force on Computing Curricula*. 2006, IEEE Computer Society.
- [16] Adroin, W.R. *Developing and deploying software engineering courseware in an adaptable curriculum framework*. in *Proceedings of the 22nd international conference on Software engineering*. 2000. New York, NY, USA: ACM



- [17] McCowan, J.D. and C.K. Knapper, An integrated and comprehensive approach to engineering curricula, part one: Objectives and general approach. *International Journal of Engineering Education*, 2002. 18(6): p. 633-637.
- [18] Wilson-Medhurst, S. Towards sustainable activity led learning innovations in teaching, learning and assessment. in *Proceedings of the 2008 Engineering Education (EE2008) Conference*. 2008.
- [19] Wilson-Medhurst, S., et al. Developing Activity Led Learning in the Faculty of Engineering and computing at Coventry University through a continuous improvement change process. in *Research Symposium on Problem Based Learning in Engineering and Science Education*. 2008. Aalborg.
- [20] Iqbal, R., et al. Activity-led learning approach and group performance analysis using fuzzy rule-based classification model. in *2013 IEEE 17th International Conference on Computer Supported Cooperative Work in Design (CSCWD)*, . 2013. IEEE.
- [21] Abran, A., et al., *Guide to the software engineering body of knowledge: 2004 version*. 2004: IEEE Computer Society, Los Alamitos, CA; Tokyo.
- [22] Lou, S.-J., et al., Using blended creative teaching: Improving a teacher education course on designing materials for young children. *Australasian Journal of Educational Technology*, 2012. 28(5): p. 776-792.
- [23] Yee, K. Interactive Techniques. [cited 2013 10th Oct]; Available from: [www.fctl.ucf.edu/teachingandlearningresources/coursedesign/assessment/content/101tips.pdf](http://www.fctl.ucf.edu/teachingandlearningresources/coursedesign/assessment/content/101tips.pdf).
- [24] Connor, A.M., J. Buchan, and K. Petrova. Bridging the Research-Practice Gap in Requirements Engineering through Effective Teaching and Peer Learning. in *Sixth International Conference on Information Technology: New Generations*. 2009. IEEE Computer Society.
- [25] Alfonso, M.I. and F. Mora, Learning Software Engineering with group work, in *16th Conference on Software Engineering Education and Training, 2003 (CSEE&T 2003)*. 2003, IEEE. p. 309-316.
- [26] Zowghi, D., Teaching Requirements Engineering to the Bahá'í Students in Iran who are Denied of Higher Education, in *Fourth International Workshop on Requirements Engineering Education and Training (REET)*. 2009, IEEE. p. 38-48.
- [27] Beatty, J. and V. Agouridas, Developing Requirements Engineering Skills: A Case Study in Training Practitioners, in *International Workshop on Requirements Engineering and Training (REET2007) 2007: India Habitat Centre, New Delhi*. p. 6-17.
- [28] Cremers, A.B. and S. Alda, Chapter 6: Requirements Elicitation II, in *Organizational Requirements Engineering*.
- [29] Thomas, P. and S. Minocha, Using a wiki to facilitate learning on a Requirements Engineering course, in *Higher Education Academy's eighth Annual Conference, 28-30 August 2007*. 2007: University of Southampton.
- [30] Hoffmann, A., Teaching Soft Facts in Requirements Engineering Using Improvisation Theatre Techniques, in *Third international workshop on Multimedia and Enjoyable Requirements Engineering - Beyond Mere Descriptions and with More Fun and Games*. 2008, IEEE: Barcelona, Catalunya p. 1-3.
- [31] Gabrysiak, G., et al. Teaching requirements engineering with virtual stakeholders without software engineering knowledge. in *5th International Workshop on Requirements Engineering Education and Training (REET)*. 2010. IEEE.
- [32] Kilicay-Ergin, N. and P.A. Laplante, An Online Graduate Requirements Engineering Course. *IEEE TRANSACTIONS ON EDUCATION*, 2013. 56(2): p. 208 - 216.
- [33] Rosca, D. An active/collaborative approach in teaching requirementsengineering. in *30th Annual Frontiers in Education*. 2000. IEEE.
- [34] Damian, D., et al. Teaching Requirements Engineering in Global Software Development: A report on a three-University collaboration. 2005. Citeseer.
- [35] Al-Ani, B. and N. Yusop. Role-playing, group work and other ambitious teaching methods in a large requirements engineering course. in *Proceedings of 11th IEEE International Conference and Workshop on the Engineering of Computer-Based Systems (ECBS '04) 2004*. IEEE.
- [36] Smith, R. and O. Gotel, RE-O-POLY: A Game to Introduce Lightweight Requirements Engineering Good Practices, in *International Workshop on Requirements Engineering and Training*. 2007: India Habitat Center, New Delhi. p. 42.
- [37] Report, F., *Computing Curriculum-Software Engineering*. 2004.
- [38] F.Dochy, M. Segers, and D.Sluijsmans, The use of self-, peer and co-assessment in hogher education: A review. *Studies in Higher Education*, 1999. 24(3): p. 331-350.
- [39] Falchikov, N., Peer feedback marking: developing peer assessment. *Programmed Learning*, 1995. 32(2): p. 175-187.

# COGENERATION TECHNOLOGY: CLEANER AND ENVIRONMENT FRIENDLY

Zeenat M.Ali\*, M. M. Tunio\*\*, A. J. Laghari\*\*\*, A.Q Laghari\*\*\*\*

## ABSTRACT

The increasing demand, growing prices and depleting resources of fossil fuels were diverting the attention towards the alternate energy source. The scenario of Pakistani sugar industries were presented in this research paper specially the bagasse production and their use for cogeneration. The bagasse content moisture 53%, dissolved substance 2-5% and fiber content 47-56%. The bulk density of bagasse in sugarcane was 45kg/L. The bagasse content in sugarcane was 24-28%. The bagasse cogeneration was the prominent and suitable option against the fossil fuels because of emission free burning, viable for energy generation in sugar mill and surplus to sell.

**Key words:** Fossil fuel, industries, sugar, cogeneration, suitable

## 1. INTRODUCTION:

Sugar industry was the leading industry of Pakistan. It produces sugar as a major item with bagasse and molasses as the residue. The molasses further processed for the production of ethanol in distilleries [1]. The juice free sugarcane was the bagasse. It was completely fibrous material. Around 80% sugars producing countries had better use and potential to utilize the bagasse effectively [2]. One of most useful use was the steam generation in sugar mills. The process by which the two forms of energy were produced as heat and electricity was known as cogeneration. In well designed cogeneration system the fully equipped boilers can generate the high pressure steam which was proceed for electricity by rotating the turbo generator blades (Fig 1).

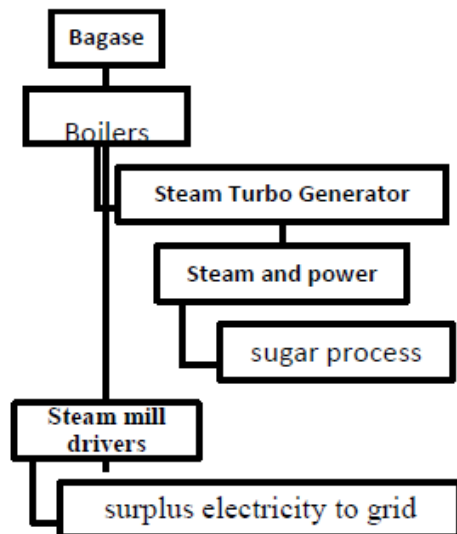

Figure-1: The simplified cogeneration Process

The cogeneration was popular in sense that sugarcane industry waste not only produces the power to meet the requirement but also surplus can be supplied to the grid stations. The cogeneration was used in wide spectrum in various industries like paper and pulp industry, petrochemical and textile and others. It significantly reduces the power consumption and in some cases the energy efficiency on cogeneration mode was up to 85% [3]. The energy sector authority's emphasizes the stack holders to generate the alternative fuels instead of fossil fuels because their prices were rising up, consequently the product cost increased and became unaffordable to common man. Also their deposits were depleting day by day and with passage of time they may be finished. Further the fossil fuel burning causes the green house gas emission and was the serious environmental concerned. That was why the need was to introduce the cogeneration to save the energy and control the emission. The lower energy-related emissions were the eutrophication potentials, acidification and global warning. So prevent the human from toxic effect of lead enriched oxygenates.

Cogeneration from bagasse was the feasible as it were the low cost, efficient and socially beneficent. It had provision to provide the renewable and clean energy source. Especially at the configurations where high pressure and temperature were maintained the cogeneration were the more efficient resources and ensuring widespread access to electricity services [4]

The bagasse was the lignocelluloses residue and was the byproduct of sugar industries used for various agricultural activities [5]. The sugarcane was content 20-30 bagasse. The 235-250kg bagasse was obtained from one ton of sugarcane [6]. The India generated 40 million tons annually and was diverting from conventional fuels to

\* Assistant Professor, Chemical Engineering Department , MUET Jamshoro

\*\* Assistant Professor, Energy & Environment Engineering, QUEST, Nawabshah

\*\*\* IARSCS/ HiTech RLs, University of Sindh, Jamshoro Pakistan

\*\*\*\* Lab supervisor, Chemical Engineering Department, MUET Jamshoro

bagasse cogeneration. The cost was cut down to half to one liter petrol [7].

The sugarcane was fifth largest crop of Pakistan in terms of area. It positioned at eleventh by production and sixtieth by yield in the world. In the list of agro based industry the sugar industry was at the second positioned and consists of seventy seven sugar mills. Those sugar mills had annual capacity over 6.1 million tones [8]. The motivated government policies and incentives of sugar mills owners encourage the growers. The sugar industry improves the energy efficiency by “green cogeneration” or ethanol production. The ethanol produced by fermentation of cellulose hydrolysis. In Pakistani economy the sugar industries and sugarcane growers were played important role in national economy. In Pakistan the seventy-one sugar mills were operational, two under construction and four completed (Table 1).

**Table 1: The overview of sugar industries of Pakistan (ref 3)**

Contribution to Economy	6.1 Million tones
Crushing capacity	3.0-4.0 Million tones
Share in GDP	1.9%
Employment	1.5 million(directly and indirectly)
Total investment	PKR 100 Billion (Approx)
Average Yield Per Hector	45.0-55.0 Million tones
Per Capita Consumption	25.8 kg per capita
Contribution to exchanger	Billion Rs.12.16

The sugar mills designed in the way to utilize the bagasse to meet their energy requirement. The alcohol and sugar were the energy intensive process. Some sugar mills established various downstream producing plants as biogas ethanol, effluent treatment chemical and paper plants (Table 2). The one -third of the bagasse was sufficient for generation of electricity and steam produced in sugar mill [9].

**Table 2: The products of sugar mill (Crushing capacity 3,000 tonnes /day) (ref 3)**

Item	Refined Sugar	Yeast	Potash Fertilizer	Pulp	Wax	Press-Mud
Tone	345	03	15	25	15	150

This research paper focused the cogeneration through bagasse in sugar industries. Also discovered their associated problems and economical, socio - environmental advantages.

**2. COMPOSITION OF BAGASSE:**

The composition of bagasse varies depends preliminary

on climatical condition, soil nutrient content, sugarcane harvesting methods and finally the efficient sugarcane handling method in sugar mills. The sugarcane from ten different locations were analyzed in quality assurance laboratory Sakrand sugar mill and their mean were tabulated (Table 3).

**Table 3: The composition of bagasse originated in sindh region**

Moisture content (%)	Dissolved substance (%)	Fiber content (%)	Bagasse content in sugarcane (%)	Bulk density (Kg/L)
53	2-5	47-56	24-28	45

The Moisture content was most important from steam generation point of view. The other important properties were the dissolved substance and fiber content. The dissolved substances were the substances in aqueous solution and were originating in the juice consisting of sugar and of impurities. These dissolved substances were in small quantities ranging from 2 to 5%. Insoluble materials consisting mainly of cellulose part of bagasse. Quantity of bagasse varies between 24 - 28% by weight of sugarcane, or approximately one quarter [10].

**3. CHEMICAL COMPOSITION:**

The elemental analysis of bagasse was done in Hitech laboratory, SU by Energy Dispersive X-Ray Spectroscopy (table 4)

**Table 4: The chemical composition of bagasse**

Carbon (%)	Hydrogen (%)	Oxygen (%)	Ash (%)
47	6.5	44	2.5

**4. BENEFITS OF BAGASSE COGENERATION:**

The sugar industry viability was increased by generating the energy from their waste material at zero cost. This was the best option to utilize the waste (bagasse) usefully. The cogeneration not only fulfills the energy requirement indigenously at low operating and transmission cost but also provides the option to sell the surplus electricity to consumers.

The bagasse cogeneration opens the doors towards the natural, clean, renewable energy and safe biomass disposal.

#### CONCLUSION:

The enhancement of power generation from bagasse cogeneration was important especially in sugar mills. The cogeneration plant must be designed and optimized. The boilers capacity, turbo generator and power cycles operated appropriately. Technically the selection of cogeneration technology, the bagasse quality and quantity, handling operation and number of processing units were important factor. The bagasse cogeneration was the highly efficient energy conversion process and yield more electricity and heat than conventional combustion process.

#### REFERENCES

- [1] Tyron Botha , Harro Von Blottiz "A Comparison of the environmental benefits for bagasse-derived electricity and fuel ethanol on a life-cycle bases"2006
- [2] Yasujiro Wakamur "Utilization of bagasse energy in thailand" "Mitigation and adaption strategies for global chang, volume8 number 3, pp 253-260(2003)
- [3] Thesis submitted to Chemical Engineering Department
- [4] Recharad Van Den Broek Tsjalle Van den BURG, Ad Van Wijk ,Wim Etal "Electricity generation from eucalyptus and bagasse by sugar mills in Nicaragua: A Comparison With Fuel Oil Electricity Generation On The Basis Of Costs Macro- Economic Impacts And Environmental Emissions" Biomass and Bioenergy, Volume19, Issue5, pp 311-335 Nov 2000.
- [5] Moisés Frías , Ernesto Villar, Holmer Savastano "Brazilian sugar cane bagasse ashes from the cogeneration industry as active pozzolans for cement manufacture" Cement and Concrete Composites, "http://www.sciencedirect.com/science/journal/09589465/33/4" Volume 33, Issue 4, April 2011, Pages 490–496
- [6] Charles Mbohwa "Bagasse energy cogeneration potential in the Zimbabwean sugar industry" Renewable Energy, http://www.sciencedirect.com/science/journal/09601481/28/2 Volume 28, Issue 2, February 2003, Pages 191–204
- [7] Dewi Restuti Axel Michaelowa, "The economic potential of bagasse cogeneration as CDM projects in Indonesia" Energy Policy, "http://www.sciencedirect.com/science/journal/03014215/35/7" Volume 35, Issue 7, July 2007, pp 3952–3966
- [8] C.A. Cardona J.A. Quintero, I.C. Paz "Production of bioethanol from sugarcane bagasse: Status and perspectives" Bioresource Technology, "http://www.sciencedirect.com/science/journal/09608524/101/13" Volume 101, Issue 13, July 2010, Pages 4754–4766
- [9] Dr. J. R. Meshram, Gargi Malik "Electricity Through Cogeneration: A Promising Development press information Bureau Government of india http://pib.nic.in/newsite/efeatures.aspx?relid=80020
- [10] Kassiap Deepchand " Commercial scale cogeneration of bagasse energy in Mauritius " Energy for Sustainable Development, "http://www.sciencedirect.com/science/journal/09730826/5/1" Volume 5, Issue 1, March 2001, Pages 15–22

# IMPACT OF URBAN AND INDUSTRIAL EFFLUENT OF HYDERABAD CITY ON FRESH WATER PINYARI CANAL

Ali Asghar Mahessar\*, Abdul Latif Qureshi\*\*, Kishan Chand Mukwana\*\*\*, Abdul Nasir Laghari\*\*\*

## ABSTRACT

Pinyari canal off-takes from Kotri Barrage which is last structure constructed at Indus River located at latitude 25°20'36.99"N and longitude 68°24'36.17"E nearby Hyderabad city, Sindh Pakistan. This canal is non-perennial which supplies water in wet season for agriculture, industrial and domestic but in dry season only for industrial and drinking purposes to Hyderabad, Tando Muhammad Khan and Sajawal Districts. As the canal is passing across the Hyderabad city, therefore, large and small industrial enterprises, urban wastewater and solid waste are being disposed off into it. Due to the direct discharge of untreated effluent into the canal, the quality of canal water is degrading at an alarming rate and do not meet NEQS. Meanwhile, about 319 industrial units have been installed in SITE Hyderabad area that are operating without any in-house treatment plants and their effluent about 60 MGD is disposed off into the canal. Different types of highly toxic chemicals are used during manufacturing process of various items. For dyeing only leather, million tones of salts and other chemical are used. The solid waste of domestic, encroached area, hospitals and slaughterhouses, containing tissues, organs, blood, drugs and chemicals, are one of the biggest sources of pollutants and being discharged directly into canal. The contaminated water of this canal is being consumed for drinking by millions of people without any treatment because ground water of canal command is highly saline which is not fit for drinking. Hence, this situation has led to create of various water-borne diseases such as dysentery, cholera, hepatitis migraine, gastroenteritis, etc.

*Keywords: Canal water, Domestic waste, Effluent, solid waste, NEQS, MGD*

## 1. INTRODUCTION

Water is life, because it is essential for the existence of human life and this substance is found in all living things. Flora and fauna have not only been resting upon water quantum but its quality standard. Therefore, Water is precious to sustain life. It is mixture of Hydrogen and Oxygen (H<sub>2</sub>O). This compound with plenty is available on the surface of earth which is major source of sustaining of environment. Presently, 90 % of the wastewater containing pollutants in high concentrations falls into Indus River and its tributaries. River water pollution has consistently increased with industrialization and urbanization [1]. Canal water is used mainly for agricultural purposes and also for drinking of human beings and domestic animals.

This effected irrigation water of the canal thus deteriorating the quality of irrigated crops [2]. Water quality of many rivers in Pakistan is being spoiled due to the inflow of industrial and domestic waste water as shown in figure 1 & 2[3]. In Pakistan, surface water (such as canals, rivers, lakes) is the major source of drinking

water. Urbanization is greatly polluting the rivers and canals and endangering aquatic life in Pakistan due to solid waste and effluent. Population encroachment and the pollution of rivers and canals with sewage water are not only spoiling the aquatic life [4] and damaging agricultural land, but also of public health concern. The same water is used for drinking purpose at some point and used for dish washing, laundry and recreational purposes. Faecaly contaminated water is a major source of diarrheal diseases in Pakistan [5].

Pinyari canal takes off from river Indus and passes through Hyderabad city with population of about 1.5 million. Sewage water is added to Pinyari canal by different pumping stations and surface sewerage drains, while it travels through Hyderabad city and affects its water quality [6]. Pakistan was hit by serious floods in the year 2010 which also reported to have deteriorated the quality of drinking water quality of the area [7]. The continuous addition of untreated wastewater into canal; the water is no more fit either for the irrigation or for the drinking purpose. The only remedy lies in the wastewater treatment plant before the effluents are added to the

\* Deputy Director, EMU, Sindh Irrigation and Drainage Authority, Hyderabad, Sindh, Pakistan  
Email: amahessar@yahoo.com

\*\* Professor, Institute of Water Resources Engineering and Management, Engineering & Technology, Jamshoro, Pakistan  
Email: latif.qureshi@faculty.mueta.edu.pk

\*\*\* Assistant Professor, Energy & Environment Department, QUEST Nawabshah  
Email: kcmukwana@quest.edu.pk

canal. There is a need that all such industries where more water use is involved should immediately arrange for treatment of their wastewater before discharging. This will have a long term positive effect [8]. The poor water quality was found in three districts of Sind province, i.e. Badin, Thatta and Thar responsible for gastroenteritis, diarrhea and vomiting, kidney, and skin problems [9].

Industrial wastewater contains toxic chemicals. It is alarming that most industries have been started without proper planning and waste treatment plants. They just dispose off untreated toxic waste into nearby drains, canals or rivers. Lahore, Faisalabad, Karachi, Sialkot contribute major pollution loads into their water bodies [10]. As described the main source of fresh water can be attributed to discharge of untreated wastewater, dumping of effluent have adverse impact on fresh water bodies [11]. The use of reclaimed wastewater by industry is a potentially large market in developed as well as in developing and rapidly industrializing countries. Industrial reuse is highly cost-effective for industries where the process does not require water of potable quality and where industries are located near urban centers where secondary effluent is readily available for reuse [12].

Municipal sewage is a major source of pollution. About 2 million wet tones of human excreta are annually produced in the urban sector of which around 50% go into water bodies to pollute them. National Conservation Strategy (NCS) states that almost 40% of deaths are related to water borne diseases. Domestic wastewater collects on the streets and in low-lying areas. The situation is further aggravated by the addition of untreated wastes from small-scale industries [13].

Wastewater use may reduce costs, especially if it is envisaged before new treatment works are built, because the standards of effluents required for various types of use

may result in costs lower than those for normal environmental protection. It also provides the possibility of recovering the resources invested in sewerage and represents a very efficient way of postponing investment of new resources in water supply [14]. However, the criteria for wastewater treatment intended for reuse in irrigation differ considerably. While it is intended that pathogens are removed to the maximum extent possible, some of the biodegradable organic matter and most of the nutrients available in the raw wastewater need to be maintained [15].

However, other research studies in the recent past demonstrated that the various quality parameters of Pakistan drinking water are not in accordance to the WHO and Pakistan standards [16]. The major sources of water pollution and ultimately of waterborne diseases are considered to be the direct discharge of domestic and industrial effluent wastes, leakage from water tanks and poor management of farm wastes [17]. Various researchers have shown that drinking water in many countries does not meet WHO standards [18].

## 2 RESEARCH AREA:

Pinyari canal is the main source of water supplying to irrigated-agriculture, municipal and industrial in the study area. The study area comprises from RD 0-RD100 of Pinyari canal which is located in the periphery of Hyderabad city. The objective of research is to determine impact of wastewater of Hyderabad city on fresh water of the canal. The left and right sides of banks of canal are completely or partially from RD 5 +0 to 60+0 under encroachment. There are many locations on the right side and the left side of Pinyari canal between RD 9 to RD 40, (RD is Reduced distance = 1000 feet) where the maximum discharge of untreated wastewater is being released into the canal as shown figure-1.



Figure-1: Pinyari, Fuleli canals and Akram wah passing across Hyderabad city



### 3 MATERIAL AND MOTHODS

#### 3.1 Identification of Inlets of the Untreated Wastewater into Pinyari Canal

Deplai Colony Wastewater Pumping Station: This pumping station is situated at Deplai colony consisted on three pipes, having 24 inches diameter delivering



Figure-1 Solid waste of the city in Pinyari Canal

There are many outlets from where wastewater enters into the canal. The wastewater of Khawja Mubark Colony is being discharged into the canal from different locations through pipes. At another outlet at outfall Structure of Kari Mori Bridge open channel of 6'x 6' wastewater is being discharge into canal. The outfall structure at the upstream of railway track has been constructed for discharging wastewater. Pumping station has been established near Grid Station in the area of Miran-jo-Paro.

At Darya khan wastewater pumping station is situated about two kilometers downstream of Ghangra Mori and receiving untreated wastewater of SITE Hyderabad area and domestic wastewater of different areas of the city. There are many small locations on left and right side of the Pinyari canal where from the untreated wastewater of municipal and industrial is being discharged into the canal. Meanwhile, there are various locations along with canal where on solid waste is dumped. The untreated waste water of the 319 Industrial units is being discharged into Pinyari canal through pumping and gravitational forces at Darya khan pumping station.

#### 3.2 Samples Collection and Analysis

Samples were collected from canals mentioned in table -1 where effluents water discharging points, upstream and downstream of disposal points. Composite sampling was carried out by collecting a series of 500ml sample every half hour basis for eight hours, combining them to form a composite sample. As general rule, it is best to analyze the sample as soon as possible after collection. Samples have been preserved in an icebox or 4°C immediately after collection. Nitric acid (HNO<sub>3</sub>) was added to the sampling bottles in quantities sufficient to lower the pH of

untreated wastewater into Pinyari canal. Ponds of wastewater of Jacob Station: Ponds constructed over 25 acres are situated at back side of Agha Khan Hospital. Jacob wastewater pumping station: It is situated near Hur camp in the north of journalist colony having delivery pipe of 18'' diameter.



Figure-2 Disposal of Industrial effluent in Pinyari Canal

the sample to just about 2, to stabilize the concentration of total and dissolved metals for a maximum of 28 days. Standard sample transfer procedures were followed to avoid confusion in sample identification, including labeling, and safe transportation to laboratory. Analysis of samples collected of wastewaters mixing with canal water of city has been carried out according to the design of research work.

**Table 1: Locations of samples collection of Pinyari Canal Water**

Sample No	Sample Type	Location
1	Wastewater	Hur Camp pump station wastewater tank.
2	Wastewater	Khawja Colony
3	Wastewater	Bus stand near Central Jail
4	Wastewater	Open drain just d/s of the Hala Road bridge,
5	Wastewater	Open drain just d/s of Kari Mori
6	Wastewater	Open drain just d/s of Preatabad bridge
7	Wastewater	Open drain near Preatabad bridge
8	Wastewater	Open drain (Shuhab Cinema reas).
9	Wastewater	Left side of the canal near Kachhi paro.
10	Wastewater	Open drain at u/s of the Railway Bridge,
11	Wastewater	Draya Khan pumping station.
12	Wastewater	Darya Khan Pumping Station
13	Wastewater	Waste effluent at Railway Bridge

### 4. RESULTS & DISCUSIONS

The demand for drinking water is increasing as population of city is growing with respect time. The figure-3 shows that demand water during 2010 year was 80 MGD but it is linearly increasing with respect of temporal becomes 88 and 90 MGD in 2025 and 2030 respectively.

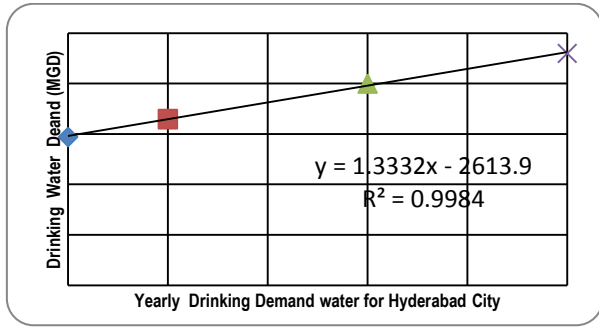

Figure-3: Drinking Water Demand

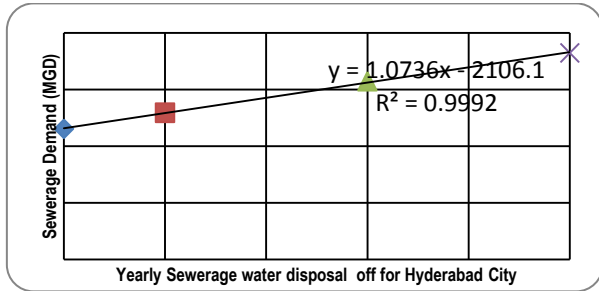

Figure-4: Sewerage water disposal demand

Hence, the figure-3 demonstrates that sewerage water disposal demand in 2010 was 50 MGD while it was increased linearly with respect of time to 62 and 72 MGD in 2025 and 2030 respectively. However, the wastewater of the city and industrial area has been discharged into Pinyari canal by pumping and gravitational flows. The field survey was carried out for identification of locations and discharge measurement wherefrom wastewater is being disposed off into canal. There are seventeen main and twenty small outlets on left side of the Pinyari canal from where untreated wastewater generated from small industries (Cottage & dyeing Ajrak) and municipal areas was being discharged into the canal. There are twenty main and many small outlet points on the right side of the Pinyari canal along wastewater generated from 319 units of SITE area as shown in Fig.4 is being released into the canal.

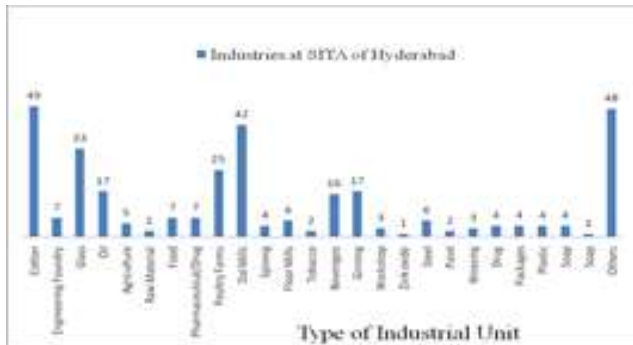

Figure-5: Different types of industries in SITE Area Hyderabad

The total estimated discharge of untreated wastewater (Industrial & Municipal) disposed off into canal is about 60 MGD. The huge volume of untreated wastewater is being released into canal without any treatment as shown in figure 5. This wastewater is polluting fresh water of canal which is used for domestic and drinking purpose at downstream of canal. This canal is non- perennial but lesser amount of water is released during dry season so that polluted water can not dilute.

There is not only wastewater discharging into canal but huge volume of solid waste is being dumped into canal. The following locations were found where solid waste is dumped on banks along with canal such as Hala road bridge on the left side of the canal; Kari Mori bridge on the left side of the canal just downstream of Pretabad bridge and Slaughter houses as shown in figure-6 and upstream of railway bridge on the right side of canal. Solid waste of burnt old batteries as shown in figure-7 after getting out lead and waste is dumped. It was amazing that lead melting process was carried out at the canal embankment and there are about 8 to 10 furnaces which are used for melting the lead from old batteries.



Figure-6: Wastewater at Kari mori Slaughter house



Figure-7: Solid waste of burnt old batteries near Darya khan pumping station

The waste material is gradually falling into the canal and polluting the canal which is very much hazardous material and dangerous for the public health and estimated quantity of solid waste is being accumulated on the embankments of the canal is about 15-20 tons per day. The huge quantum of solid waste creates slow poison in shape of leaching various chemicals permanently into canal. Moreover, there is not only problem of disposing of wastewater, sludge but waste of animals into canal. Moreover, the buffaloes farms were constructed in encroached area i.e 04 numbers of Buffalo Farms (B.F)

on left side of the canal just u/s of the Bypass bridge, each farm have 15 to 40 buffaloes; 06 numbers of B.F on right side of the canal just u/s of the Bypass bridge each farm have 10-35 buffaloes, 8 numbers of B.F on left side of the canal between Bypass road bridge and Hala road bridge each farm have 10-25 buffaloes. This is more harmful for creating water borne diseases in mankind and ecosystem which are utilizing water of irrigation canal.

For this research the samples of wastewater collected from outfall structures of wastewater into canal were analyzed from Hi Tech laboratory of Sindh University Jamshoro. The results of the physico-chemical analysis of parameters of samples are described individually.

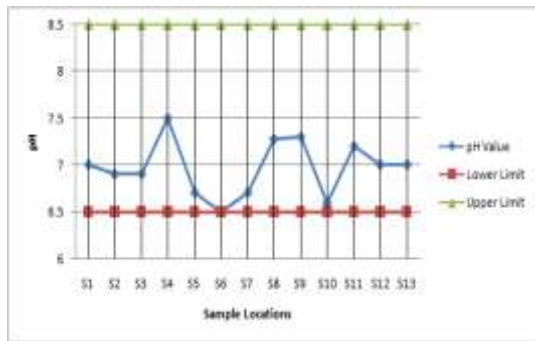

Figure-8: pH values

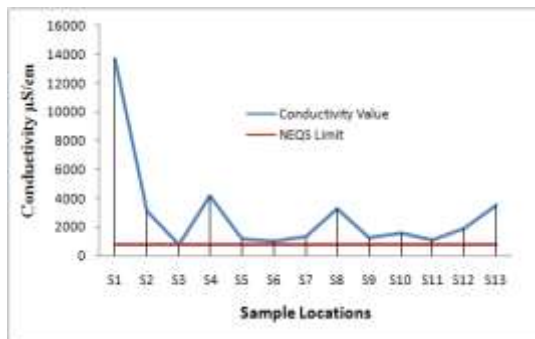

Figure-9: Conductivity values

The pH is a measure of the acidic or basic (alkaline) nature of a solution. A pH range of 6.5 to 8.5 appears to provide protection for the life of freshwater fish and bottom dwelling invertebrates. The pH values of all samples are within the permissible limits of NEQS shown in figure-8. Electrical Conductivity (EC) of water is a measure of the ability of a solution to conduct an electrical current. The salinity of treated wastewater to be used for irrigation is estimated by measuring its electrical conductivity. In most of the cases, the conductivity level exceeds than the value of NEQS (680  $\mu\text{S}/\text{cm}$ ) permissible within limit NEQS. The electrical conductivity of all samples ranges from 760 $\mu\text{S}/\text{cm}$  to 13700  $\mu\text{S}/\text{cm}$ . Almost the conductivity of all samples is higher than permissible limits of NEQS shown in figure-9.

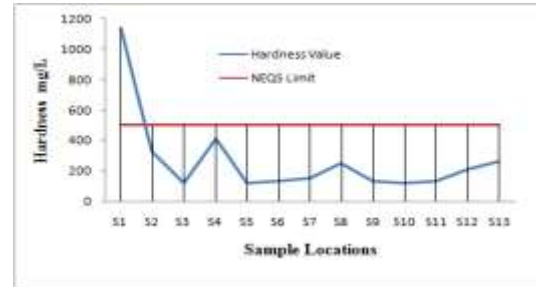

Figure-10: Hardness

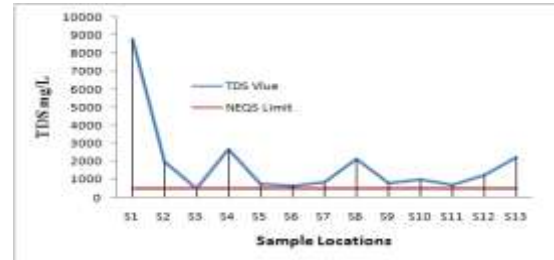

Figure-11: TDS

The hardness of all wastewater samples were within the limits of NEQS but except sample 1, and the higher value was found at location sample location S1 is due to the release of effluent from waste water ponds and industrial area shown in figure-10. A high concentration of TDS is an indicator of possibly high value of contamination. The TDS results of samples analyzed show that higher value of samples than permissible limits of NEQS in almost cases. The sample No 1 indicates that very high Total Dissolved solids available in the coming wastewater rather than the other locations. It is manifest from result that all values of TDS of all samples are higher to permissible limit of NEQS shown in figure-11.

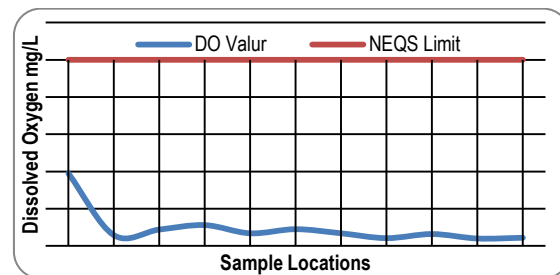

Figure-12: Dissolved Oxygen

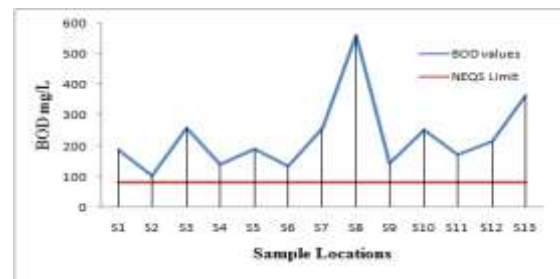

Figure-13: BOD



The Dissolved Oxygen is one of important parameter in water quality analysis i.e. index of physical and biological process going in water. The DO level in natural as well as waste water depends on physical, chemical and biological activities of water bodies. Aquatic ecosystem is totally depends on dissolved oxygen various biochemical changes. The recommended value of dissolved oxygen in normal drinking water is 8 mg/l and high dissolved oxygen was found its normal value [9]. Dissolved oxygen (DO) is an indicative of oxygen depletion shown in figure-12. The BOD has almost universally been adopted as a measure of relative pollution effect. The values of the samples of wastewater are higher values than the permissible limits in NEQS. The values of samples of surface range from 1.7 to 560 shown in figure-13. This variation is due to wastewater of industrial area.

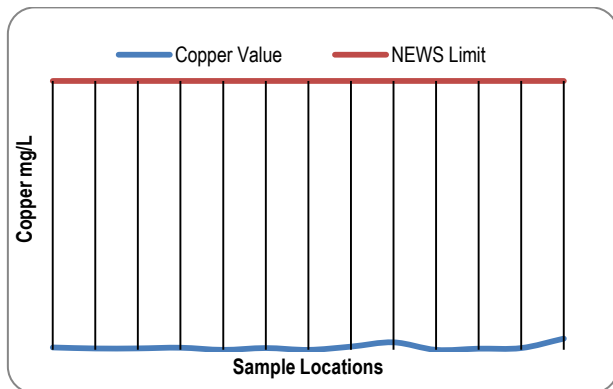

Figure-14: Copper level

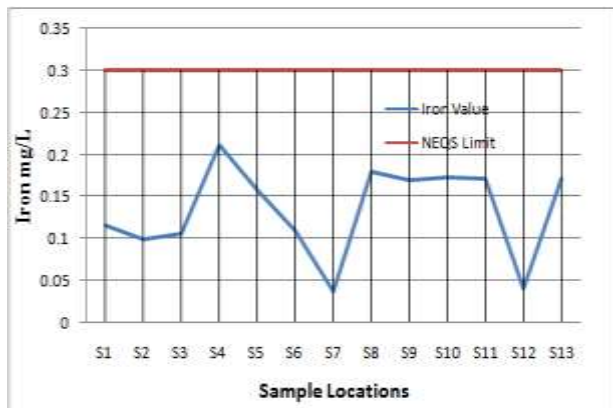

Figure-15: Iron (Fe) level

The results of all the samples indicate that they have lesser quantity of Copper (Cu) available in the wastewater as compared to the NEQS shown in figure-14. Since the availability of greater quantity is harmful for the public health, therefore it is necessary to have a continuous monitoring and testing the wastewater samples from SITE area. The results Fe samples presents the lesser quantity of Iron (Fe) is available in the wastewater coming out from domestic and the industrial units shown in figure-15.

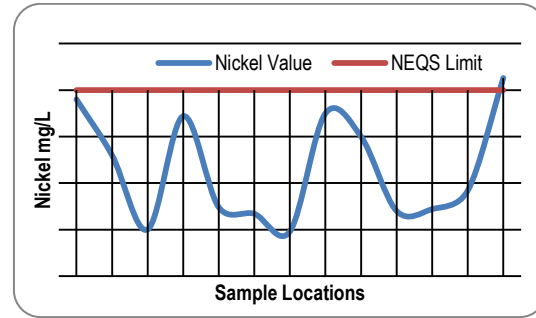

Figure-16: Nickel level

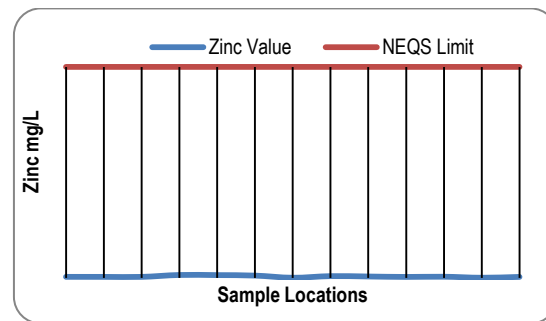

Figure-17: Zinc level

All the samples indicate less concentration of Nickel (Ni) available as compared with the NEQS as shown in figure-16, due to the poisonous metal, it is necessary to have continuous monitoring and testing of the samples at SITE area. Results of Zinc show lesser concentration of Zinc metal available in the wastewater as shown in figure-17. This might be due to non use of the ingredients containing of the Zinc metal during the manufacturing processes in the industrial units.

The major impacts of the discussed pollutants were observed on fresh canal water which is main source of drinking water of millions of people who are settled in command area of canal. However, this contaminated water leads various waterborne diseases among the masses i.e Brain damage or suffocation, Gastric and stomach cancer in human, The death and decay of vegetation and aquatic life and digestive problem for humans, Human illness and affect plant growth and fish and aquatic life, Human health and the environment, Dental, bone and skeletal problems, Typhoid fever, dysentery, viral and bacterial gastroenteritis and hepatitis as well as minor respiratory and skin diseases.

## 5. CONCLUSIONS

No arrangement of in house treatment plants has been done for treatment of the domestic and industrial wastewater by Polluters. The generated effluent caused various waterborne diseases among the local people, livestock and also flora and fauna. The results of parameters of some samples revealed that higher values

of Conductivity, TDS, Conductivity and Hardness and BOD. Whereas it is concluded that untreated wastewater coming through these locations of various municipal and industrial, encroached areas are main source of polluting of the fresh water of canal. However, Discharging of untreated wastewater (urban and Industrial units) and solid waste (municipal/domestic, agricultural and industrial) into canal must be controlled. The buffalo farms constructed on the both sides of canal may be shifted. Hence, safer disposal arrangements should be adopted by using alternate routes to dispose of the untreated wastewater. Meanwhile, awareness programmes may be arranged to the local people for safely disposal and management of wastewater for protecting various water borne diseases such as dysentery, cholera, hepatitis and migraine. The wastewater of city and industrial site should be treated and it may be released for utilization for agricultural and forestry purpose. The city government and industrial sector should be legally bound for installation of treatment plants.

Sindh EPA should play a proactive role and regularly monitor the pollution levels with coordination of the all stakeholders. The prevailing legislation be involved on all industries throwing their untreated effluent in canals. The city government of Hyderabad, Tando Muhammad Khan and Sajawal may establish working group to regularly observe water quality in the canal and take appropriate administrative decisions to address this adverse environmental issue.

**Acknowledgement:** The authors are thankful to Sindh Irrigation and Drainage Authority and Project Management Office, Sindh Irrigation Department for providing information and also Institute of Water Resources and Engineering Management for facilitating to complete this work.

## REFERENCES

- [1] Ghumman, A. R. Assessment of water quality of Rawal Lake by long-time monitoring. *Environmental Monitoring and Assessment*, 2011, 180,115-126.
- [2] Shakir, H. A.; Qazi, J. I. Impact of industrial and municipal discharges on growth coefficient and condition factor of major carps from Lahore stretch of River Ravi. *Journal of Animal and Plant Sciences*, 2013, 23(1), 167-173.
- [3] Aziz, J. A. Management of source and drinking-water quality in Pakistan. *Eastern Mediterranean Journal of Health Sciences*, 2005, 11(5-6), 1087-98.
- [4] Ejaz, N.; Hashmi, H. N.; Ghumman, A. R. Water quality assessment of effluent receiving streams in Pakistan: A case study of Ravi River. *Mehran University Research Journal of Science and Technology*, 2011, 30 (3), 383-396.
- [5] I.A. Ansari, V.K. Dewani and M.Y. Khuhawar, *J. Chem. Soc. Pak.* 21 (1999) 359.
- [6] Baig SA, Mahmood Q, Nawab B, Shafqat MN, Pervez A, Zeb BS (2011), "Improvement of drinking water quality by using of plant biomass through household bios and filter-A decentralized approach", *Ecol. Eng.* 37(11):1842-1848.
- [7] M.H.S.Watoo,F.H. Watoo,T. G. Kazi, S. A. Tirmizi, M. I. Bhanger, R. B. Mahar and J. Iqbal, (2004), *Quality Characteristic of Phuleli canal Water for irrigation Purpose*" NCLEAM, ISSN 0029- 5698, 41 (1-4) 2004 : 69-75.
- [8] Memon M, Soomro MS, Akhtar MS, Memon KS (2011), "Drinking water quality assessment in southern Sindh" (Pakistan). *Environ. Monit. Assess.* 177:39–50.
- [9] M.A. Saleemi, *Environmental Pollution Unit, WWF-Pakistan.* 1993.
- [10] Sohag M.A. and Mahessar A. A. *Pollution of Indus Waters and the Drainage system of Sindh*, published paper in proceedings of Environmentally Sustainable Development in International Conference, held by Department of Environmental Sciences, COMSATS Institute of Information Technology Abbotabad. (2005).
- [11] WHO/FAO/UNCHS/UNEP Regional Workshop for the Americas on Health, Agriculture and Environmental Aspects of Wastewater Use. Jiutepec, Morelos, Mexico, 8-12 November, 1997, Institute Mexicano de Tecnologia de Agua (IMTA), Jiutepec, Mexico.
- [12] WWF-, *Environmental Pollution Unit, WWF- Pakistan.* 2000
- [13] Laugeri, L. *Economic aspects of wastewater reuse.* Unpublished document. World Health Organization, Geneva. 1989.
- [14] Crook, J., Ammerman, D.K., Okun, D.A. and Matthews, R.L. 1992 *Guidelines for Water Reuse.* Camp Dresser & McKee, Inc., Cambridge, Massachusetts.
- [15] Rahman AU (1996), "Ground water as Source of contamination for water supply in rapidly growing mega cities of Asia." Case of Karachi, Pakistan. *Water Sci. Technol.* 34(7-8):285-292.
- [16] Chilton PJ, Jamieson D, Abid MS, Milne CJ, Ince ME, Aziz JA (2001), "Pakistan water quality mapping and management project. Scoping study, Draft final report", Water engineering and development centre, Loughborough University & London School of Hygiene & Tropical Medicine, W ELL Task 568. Loughborough, UK.
- [17] Malana MA, Khosa MA (2011), "Ground water pollution with special focus on arsenic", *Dera Ghazi Khan. Pakistan. J. Saudi Chem. Soc.*15:39–47.
- [18] Farid S, Baloch MK, Ahmad SA (2012), "Water pollution: Major issue in urban areas", *Int. J. Water Res. Environ. Eng.* 4(3):55-65.

# COMPARATIVE ANALYSIS OF WEATHER PARAMETERS AT TWO LOCATIONS FOR VIABILITY OF SOLAR ENERGY SYSTEMS

Abdul Qayoom Jakhrani\*, Andrew Ragai Henry Rigit\*\*, Muhammad Moosa Jakhrani\*\*\*, Sikandar Ali Channa\*\*\*\*

## ABSTRACT

The aim of this work is to analyze the weather parameters for determination of optimum photovoltaic system slope and viability of solar energy systems at two locations namely Nawabshah, Pakistan and Kuching, Malaysia. In order to achieve the objectives, twenty two years (1983-2005) satellite-derived monthly mean data for both locations is acquired from National Aeronautics and Space Administration. The data includes mean daily ambient, maximum and minimum temperatures, daylight hours, relative humidity, atmospheric pressure, rainfall, wind speed, optimal angle and sunset hour angle. First, the data is summarized then it is evaluated with the help of Statistical Package for the Social Sciences software and finally compared. It is discovered from the analysis that Nawabshah, Pakistan is more feasible location for installation of solar energy generators as compared to Kuching, Malaysia. Kuching is located near the equator, where it confronts cloudy skies throughout the year and receives heavy rainfall especially from October to March. The annual optimum solar energy outputs could be achieved at a system slope of  $21^\circ$  towards true south for Nawabshah. Lower system slopes is found to be more practicable at Kuching due to its geographical position.

**Key words:** Weather parameters, optimum slope, relative humidity, rainfall, ambient temperature

## 1. INTRODUCTION

Energy is crucial for the social development and economic growth of any nation. The features of life are associated to the per capita consumption of energy. Energy demand is gradually rising since last few decades in all countries due to the development of agricultural and industrial activities [1]. The increasing energy demand can no longer be satisfied by the conventional energy technologies. It is reported that the major cause of global warming are greenhouse gases, which are emitted from combustion and utilization of fossil fuels [2]. It is also believed that alternative energy sources can help to reduce the greenhouse gas emissions and to enhance the energy security [3]. Out of all alternative energy sources, solar energy is one of the principal green energy sources freely available, clean and abundant in most places throughout the year [4]. Solar energy consists of two parts, namely extraterrestrial and global solar energy. The amount of solar energy above the atmosphere is extraterrestrial, which is almost constant with  $1367 \text{ W/m}^2$ . The global solar energy is that part of radiation available under the atmosphere and reaches over the surface of earth [5]. The amount of global solar radiation varies from place to place due to different geographical and

weather conditions. Therefore, the influence of weather parameters is crucial for growth and development of solar energy systems. Since, different techniques can be applied to determine the influence of weather parameters on amount of exploitable energy. Top down approaches is one of the most widely adapted methods for precise determination of available energy. This approach starts with the calculation of energy potential reaching at the surface of earth. However, this amount is influenced by various factors such as the earth's geometry, revolution and rotation as well as the atmospheric attenuation due to scattering and absorption by gases, solid and liquid particles and clouds [6].

Moreover, the actual amount of solar radiation reaching any particular location also depends upon the prevailing climate and local topography of the area [7]. The design, optimization and performance evaluation of solar technologies on any particular location requires reliable data. Such data can be obtained from various sources, such as ground measurements by pyranometers or derived from satellites or combination of both [6-10]. Since, the data measured by meteorological stations is sometimes questionable because of calibration problems and defective recording equipments. The satellite-based data

\* Assistant Professor, Department of Energy and Environment Engineering, Quaid-e-Awam University of Engineering, Science and Technology (QUEST), Nawabshah, Pakistan - Email: aquinimas@hotmail.com

\*\* Professor, Department of Mechanical and Manufacturing Engineering, Faculty of Engineering, Universiti Malaysia Sarawak (UNIMAS), Sarawak, Malaysia

\*\*\* Postgraduate Student, Department of Electrical Engineering, Quaid-e-Awam University of Engineering, Science and Technology (QUEST), Nawabshah, Pakistan

\*\*\*\* Assistant Professor, Department of Mining Engineering, Mehran University of Engineering and Technology (MUET), Jamshoro, Pakistan



has proven to be highly valuable for the solar energy community over the last decades. However, it did not consider local geographical conditions, hence overestimates the amount of available solar radiations of the region [8-11]. Such comparative data is given in Figure 1. For that reason, the acquired data requires confirmation by means of comparison against measured or other reference data series. Thus, it is important to work out the similarities or the differences between the two data sets. The purpose of this study was to analyze the data of two different locations namely Nawabshah, Pakistan and Kuching, Malaysia, and to examine the variation and correlation of data sets.

Nawabshah is located in the heart of Sindh Province, Pakistan in South Asia and Kuching is located in the western side of Borneo Island, East Malaysia in South East Asia. Nawabshah city is considered as one of the hottest city in Pakistan. The climate is generally dry and hot, but sometimes the temperature falls to 0°C in January. On the other hand, Kuching has tropical rainforest climate moderately hot but very humid at all times and receives substantial amount of rainfall. Kuching is the wettest populated area in Malaysia with an average of 247 rainy days per year. The temperature stays almost constant throughout the year and rarely falls down up to 19°C [12].

Malaysia changed the Four-Fuel Policy based on oil, gas, coal and hydropower to the Five-Fuel Policy with the addition of renewable energy as the fifth source of fuel [13]. In addition, Pakistan heavily depends on fuel imports to meet its growing energy needs. However, it is gifted with large deposits of lignite coals as well as substantial amounts of renewable energy resources including hydro, wind and solar. Currently, Fauji Fertilizer Company Energy Limited is building 49.5 MW Wind Energy Farm at Jhimpir near Karachi and also work is in process to achieve financial close for two wind projects, 50MWs each at Gharo, Thatta District, Sindh [14].

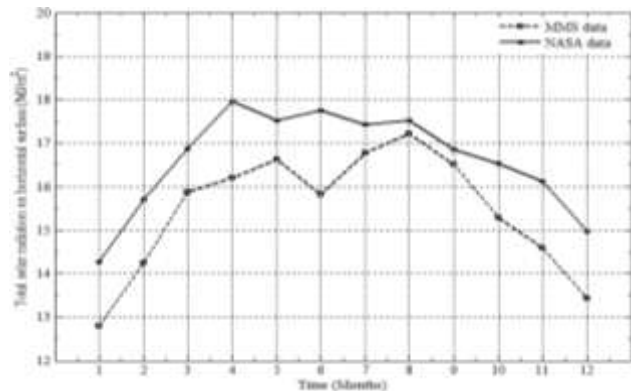

Figure-1. Measured global solar radiation data at Kuching by MMS and NASA

## 2. METHODOLOGY

The study was carried out to compare the weather data of Nawabshah (26.3°N and 68.4°E), Pakistan and Kuching (1.48° N, 110.33° E) Malaysia. The meteorological data of both locations were acquired from NASA Surface Meteorology and Solar Energy [15]. The methods, parameters methodology of acquired data are shown in Table 1. The data is analyzed and investigated with the help of SPSS software. The results of meteorological parameters are graphically shown in Figures 2-5.

**Table 1. Methodology and Techniques Used for Acquiring of Satellite Derived Data**

Parameters and Methods	Methodology
Database method	NASA SSE 6
Extent	Global
Data inputs	GEWEX/SRB, 3 + ISCCP Satellite, Clouds + NCAR, Reanalysis
Period	1983–2005
Time resolution	3-h
Spatial resolution	1 arc-degree x 1 arc-degree
Global horizontal radiation	Satellite model [16]
Diffuse fraction	Diffuse Radiation Model [17]
Inclined surface (diffuse model)	RetScreen Model [18]

## 3. RESULTS AND DISCUSSIONS

The different weather parameters such as ambient temperature, relative humidity, rainfall, wind speed, system slope and hour angle were considered this analysis. The results of these parameters were evaluated with the help of SPSS software and critically examined by comparing their values.

### 3.1. Average, Minimum and Maximum Ambient Temperature

The behavior of air temperature of both places is shown in Figure 2. It was observed that the maximum mean value of ambient temperature ( $T_a$ ) at Nawabshah was 32.9°C in the month of June and the minimum value was 16.0°C in January with an annual mean value of 26.3°C. Similarly, the maximum value of ambient temperature ( $T_a$ ) in Kuching was 27.2°C in the month of August and the minimum value was 25.1°C in January with an annual average value of 26.1°C. Besides average ambient temperature, the maximum mean value of minimum air temperature ( $T_{min}$ ) in Nawabshah was 27.6°C in the month of June and the minimum value was 10.1°C in the month of January with an annual mean value of 20.7°C. The results show that the maximum value of minimum air temperature ( $T_{min}$ ) in Kuching was 24.3°C in the month of August and the minimum value was 23.3°C in January with an annual average value of 23.7°C.

The analysis exposed that the maximum mean value of maximum air temperature ( $T_{max}$ ) in Nawabshah was 39.2°C in the month of May and the minimum value was 23.3°C in January with an annual mean value of 32.6°C. Similarly, the maximum value of maximum air temperature ( $T_{max}$ ) in Kuching was found to be 30.3°C in the month of August and the minimum value was 27.1°C in January with an annual average value of 28.6°C. The results showed that the range of ambient temperature at Nawabshah was around 15°C and at Kuching, it was not more than 2.0°C as shown in Figure 2. The trend of ambient temperature at Nawabshah is totally different than that of Kuching. As in winter season, the temperature is too low and in summer season it is too high and sometimes reaches up to 50°C at Nawabshah.

### 3.2. Daylight Hours, Relative Humidity and Atmospheric pressure

The statistical values of day light hours, relative humidity and atmospheric pressure are demonstrated in Figure 3. It was observed that the maximum average daylight hours ( $N$ ) at Nawabshah were 13.7 hours in the month of June and the minimum value was 10.5 hours in the month of December. The maximum average daylight hours ( $N$ ) in Kuching was found to be 12.2 hours in the months of June and July and the minimum value was 12 hours in the months of January, February, October, November and December. As shown in Figure 3, the range of daylight hours at Nawabshah was almost 3.5 hours, it means that in winter season, the days were very short and nights were too long and in summer vice versa. However, at Kuching the days and nights were almost same throughout the year as the difference between day and nights in the summer and winter was just 0.2 hours. In addition, the maximum mean value of relative humidity ( $RH$ ) at Nawabshah was found to be 61.7% in the month of August and the minimum value was 26.7% in November with an annual mean value of 38.2%. The maximum value of relative humidity ( $RH$ ) at Kuching was found to be 84.5% in the month of January and the minimum value was 69.9% in August with an annual average value of 78.6%. The higher percentage of  $RH$  in the months of July and August at Nawabshah was due to the monsoon season otherwise the climate is usually dry. It was found from the analysis that the average difference between higher and lower relative humidity at Nawabshah was 35%, whereas, at Kuching, it was just 14%. However, the average relative humidity at Kuching was found to be almost double than that of Nawabshah, due to higher percentage of vapors in the atmosphere.

Moreover, the maximum mean value of atmospheric pressure ( $P_{atm}$ ) at Nawabshah was 100 kPa in the months of January and December and the minimum value was 98.2 kPa in the months of June and July with an annual mean value of 99.2 kPa. Similarly, the maximum mean

value of atmospheric pressure ( $P_{atm}$ ) at Kuching was 100 kPa in all months except 99.9 kPa in the month of May. In general, the average atmospheric pressure of Nawabshah was found to be slightly lower than that of Kuching with a difference of only 1.7 kPa.

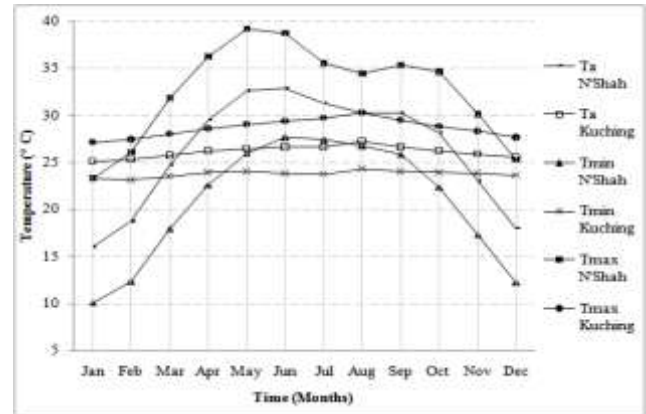

Figure-2. Comparative Analysis of Ambient Air Temperature at Nawabshah and Kuching

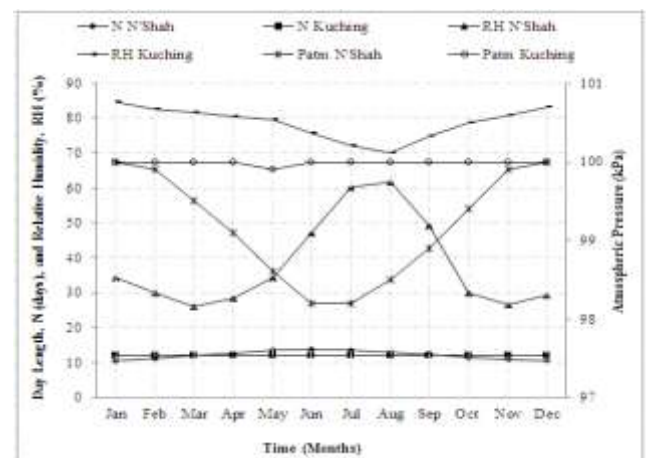

Figure-3. Comparative Analysis of Monthly Mean Daylight Hours ( $N$ ), Relative Humidity ( $RH$ ) and Atmospheric Pressure ( $P_{atm}$ ) at Nawabshah and Kuching

### 3.3. Rainfall Conditions and Wind Speed

The rainfall conditions and behavior of winds are graphically shown in Figure 4. It was discovered from the analysis that the maximum average of rainfall at Nawabshah was 2.36 mm/day in the month of July and the minimum value was 0.04 mm/day in the month of November and annual average value was found to be 0.56 mm/day. The maximum average of rainfall in Kuching was found to be 12.0 mm/day in the month of January and the minimum value was 6.51 mm/day in the month of July, whereas, the annual average rainfall was 8.79 mm/day. It was found from the analysis that Kuching is one of the rainiest places of the world and Nawabshah confronts low rainfall except monsoon season. However, at Kuching, the rainfall was rather low in the months from

May till August as compared to other months. Moreover, the maximum average of wind speed ( $V_w$ ) at Nawabshah was found to be 4.57 m/s in the month of June and the minimum value was 3.22 m/s in the month of November and annual average value was 3.75m/s. Similarly, the maximum average of wind speed ( $V_w$ ) at Kuching was found to be 3.74 m/s in the month of August and the minimum value was 1.79 m/s in the month of July, whereas, the annual average rainfall was 2.67 m/s. In contrary to the rainfall, the wind speed at Kuching was found to be lower than that of Nawabshah due to equatorial position.

### 3.4. Optimum Slope and Hour Angle

The values of optimum slope and hour angle for PV system installations at both places are given in Figure 5. It was observed that the maximum optimum angle ( $\beta_{opt}$ ) at Nawabshah was  $50.0^\circ$  in the month of January and the minimum value was  $0^\circ$  in the months of May, June and July with an annual mean value of  $24.8^\circ$ . Likewise, the maximum optimum angle ( $\beta_{opt}$ ) at Kuching was found to be  $25.0^\circ$  in the month of December and the minimum value was  $1.0^\circ$  in September with an annual average value of  $14.1^\circ$ . The results showed that the range of slope at Nawabshah was  $50.0^\circ$ , whereas at Kuching, it was only half of that value e.g.  $25.0^\circ$ . It is because the sun is going far away from the location (Nawabshah) in winter and reaching towards location in summer. In contrary, Kuching is located near the equator, where the sun is almost at same distance in summer as well as in winter months. Furthermore, the maximum hour angle ( $\omega$ ) at Nawabshah was  $102.0^\circ$  in the month of June and the minimum value was  $77.9^\circ$  in the month of December. The maximum hour angle ( $\omega$ ) at Kuching was found to be  $90.6^\circ$  in the month of June and the minimum value was  $89.3^\circ$  in December. The range of hour angle at Nawabshah was  $24^\circ$ , whereas at Kuching it was within  $2^\circ$ .

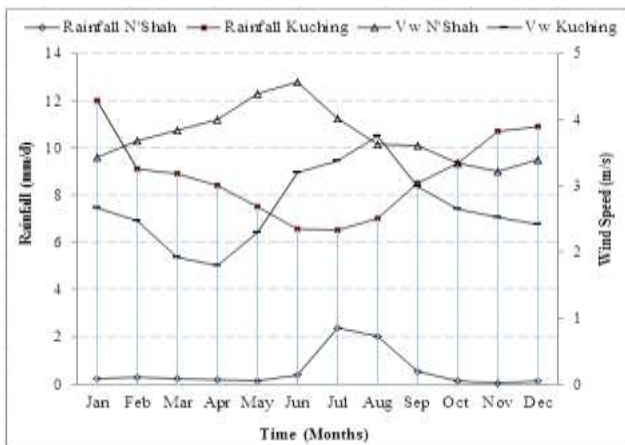

Figure-4. Comparative Analysis of Rainfall and Wind Speed above 10 m height at Nawabshah and Kuching

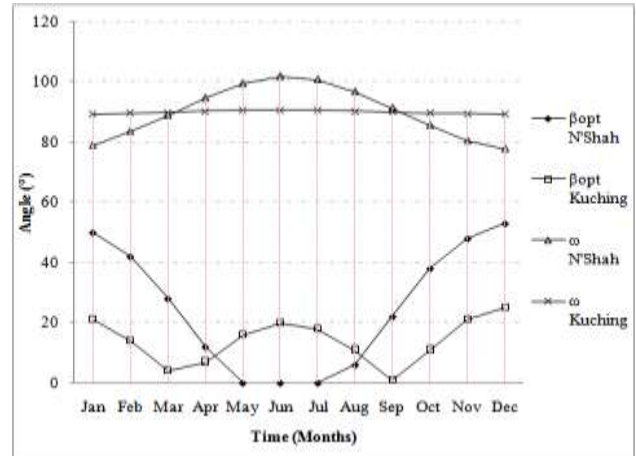

Figure-5. Comparative Analysis of Optimal Angle,  $\beta^\circ$  and Sunset Hour Angle,  $\omega$  at Nawabshah and Kuching

In general, it was exposed from the analysis that the propensity of ambient temperature at Nawabshah was found to be totally different than that of Kuching. At Nawabshah, the temperature was found to be too low in winter and too high in summer where it sometimes reaches up to  $50^\circ\text{C}$ . At Kuching, the range of ambient temperatures throughout the year was quite low. Moreover, the relative humidity in the months of July and August at Nawabshah was found to be high due to the monsoon season otherwise it is rather dry. Study reveals that the average difference between higher and lower relative humidity at Nawabshah was 35%, whereas, at Kuching, it was just 14%. Furthermore, the range of solar system angle at Nawabshah was quite high with  $50^\circ$  and at the Kuching it was only  $25^\circ$  due to geographical position. In Nawabshah, the lengths of days in winter season were short and nights were long and vice versa in summer. The lengths of days and nights at Kuching were found to be same throughout the year with a difference of only 0.2 hours. The relative humidity at Kuching was found to be almost double than that of Nawabshah, due to presence of large amount of vapors in the atmosphere due to its equatorial position. In general, the average atmospheric pressure of Nawabshah was quite low as compared to Kuching with a difference of only 1.7 kPa.

### 4. CONCLUSIONS

The weather data of Nawabshah, Pakistan and Kuching, Malaysia was acquired from National Aeronautics and Space Administration (NASA) Surface Meteorology and Solar Energy website. The data was then summarized, evaluated and compared with the help of SPSS software. It was revealed from the analysis that the average ambient and maximum temperature was higher at Nawabshah, while Kuching faces higher values of average minimum temperature as well as relative humidity. At Kuching, the sky dome was found to be almost covered with clouds and receives heavy rainfall throughout the year. In

contrary to Nawabshah, the temperature and wind speed as well as other weather parameter values were found to be uniform at Kuching because of its equatorial position. The annual optimum system outputs could be achieved with system installation at an angle of 21° tilted towards true south for Nawabshah, whereas, lower system slopes are feasible at Kuching.

The results revealed that the variation and range of parameter values were higher at Nawabshah as it confronts less rainfall and cloud cover in the whole year. It was concluded that Nawabshah is more suitable location for the development of solar energy systems as compared to Kuching due to clear sky conditions.

## REFERENCES

- [1] F.R. Martins, E.B. Pereira, S.A.B. Silva, S.L. Abreu, S. Colle. Solar energy scenarios in Brazil, Part one: Resource assessment, *Energy Policy* 36 (2008) 2853–2864.
- [2] G. Wu, Y. Liu, T. Wang. Methods and strategy for modeling daily global solar radiation with measured meteorological data- A case study in Nanchang station, China, *Energy Conversion and Management* 48 (2007) 2447–2452.
- [3] A.A. El-Sebaai, F.S. Al-Hazmi, A.A. Al-Ghamdi, S.J. Yaghmour, Global, direct and diffuse solar radiation on horizontal and tilted surfaces in Jeddah, Saudi Arabia, *Applied Energy* 87 (2010) 568–576.
- [4] T.Khatib, A.Mohamed, K. Sopian, A review of solar energy modeling techniques, *Renewable and Sustainable Energy Reviews* 16 (2012) 2864– 2869.
- [5] J.L. Torres, M. De Blas, A. Garcia, A. de Francisco, Comparative study of various models in estimating hourly diffuse solar irradiance, *Renewable Energy* 35 (2010) 1325–1332.
- [6] A.Angelis-Dimakis, M.Biberacher, J. Dominguez, G. Fiorese, B. Espinar, L.Ramirez, A. Drews, H.G. Beyer, L.F. Zarzalejo, J.Polo, L. Martin, Analysis of different comparison parameters applied to solar radiation data from satellite and German radiometric stations, *Solar Energy* 83 (2009) 118–125.
- [7] J.C. Lam, K.K.W. Wan, L.Yang, Solar radiation modelling using ANNs for different climates in China, *Energy Conversion and Management* 49 (2008) 1080–1090.
- [8] M. Journee, R. Muller, C. Bertrand, Solar resource assessment in the Benelux by merging Meteosat-derived climate data and ground measurements, *Solar Energy* 86 (2012) 3561–3574.
- [9] A.Q. Jakhrani, A.K. Othman, A.R.H. Rigit and S.R. Samo, Assessment of Solar and Wind Energy Resources at Five Typical Locations in Sarawak. *Journal of Energy & Environment*, Vol. 4 (1), 2012, 1-6. ISSN: 1985-7462.
- [10] A.Q. Jakhrani, A.K. Othman, A.R.H. Rigit, S.R. Samo, and S.A. Kamboh, A Simplified Analytical Method for Size Optimization of a Standalone PV System. *NED University Journal of Research-Applied Sciences*, X (2), 2013, 9-18. ISSN 1023-3873.
- [11] A.Q. Jakhrani, S.R. Samo, S.A. Kamboh, J. Labadin, and A.R.H. Rigit, An Improved Mathematical Model for Computing Power Output of Solar Photovoltaic Modules. *International Journal of Photoenergy*, 2014, Article ID 346704, 9 pages.
- [12] World Climate (WC), Kuching, Malaysia Weather History and Climate Data. Available at <http://www.worldclimate.com/>.
- [13] Department of Statistics Malaysia, Sarawak (DSMS), Meteorological Observations at Meteorological Station, Kuching International Airport. *Monthly Statistical Bulletin*, Kuching, January 2009: 09 November, 2013. ISSN 1823-1640.
- [14] K. Y. Awan, A. Rashid, Overview of Pakistan's Electricity Crisis, Generation-Mix and Renewable energy scenarios, *International Journal of Engineering and Technology* 1 (4) (2012) 321-334.
- [15] NASA Surface Meteorology and Solar Energy, Available at: <https://eosweb.larc.nasa.gov/sse/>
- [16] R.T. Pinker, I. Laszlo, Modeling surface solar irradiance for satellite applications on a global scale, *Journal of Applied Meteorology* 31 (1992)194–211.
- [17] D.G. Erbs, S.A. Klein, J.A. Duffie, Estimation of the diffuse radiation fraction for hourly, daily and monthly average global radiation, *Solar Energy* 28 (1982) 293–302.
- [18] J. Duffie, A. Beckman, *Solar engineering of thermal processes*, 3<sup>rd</sup> Edition, John Wiley & Sons., 2006.

# GROUND WATER QUALITY OF KHAIRPUR MIR'S SINDH: A CASE STUDY

Zeenat M.Ali\*, Zulfiqar Ali Bhatti\*, Kishan Chand Mukwana\*\*, M.M Tunio\*\*

## ABSTRACT

Groundwater contamination in rural sindh was big health concern for the living creatures. Many disaster diseases caused by the contaminated water. The research was conducted in Ranipur city of District Khairpur Mir's to determine the groundwater quality. The ten locations were selected for monitoring the water quality. The pH, temperature, electrical conductivity (EC) and total dissolved solids (TDS) were analyzed. The Arsenic was also monitored by Kit method. The results revealed that pH ranged from 6.16- 8.6, EC from 340-1940  $\mu\text{S}/\text{cm}$ , TDS from 10-970 mg/L and Arsenic was 0.00001-2.14  $\mu\text{g}/\text{L}$ . The temperature of underground water was found averagely 30.93  $^{\circ}\text{C}$ . The overall quality of groundwater was found satisfactory except the EC of eight locations of Ranipur city of Kharpur Mirs.

**Keys words:** Ground water, Sample, Monitor, Conductivity

## 1. INTRODUCTION

Water is essential for life; no living thing survives without water. Human beings, animals and plants need specific amount of water for their various purposes. There were two main sources of water for use, the first one was groundwater and other was surface water. The groundwater is present below the water table in saturated zone, whereas the surface water at the surface of earth. Though the water exists in earth in large quantity but below 3% was the fresh water for use. Nearly 20% of the Global water withdrawals were concerned with groundwater approximately 1.5 billion peoples depended on ground water for their drinking purpose [1]. A Person needs approximately 01 gallon /day for hydration. In Pakistan each person uses 188 gallons of water in one day for drinking, washing and cooking and other purposes. Approximately one-sixth of total human population has no easy access to safe drinking water [2]. The unplanned urban development and human activities contaminated the groundwater reservoirs. The agrochemicals runoff, untreated effluent discharge and solid waste leaching was the main causes of groundwater contamination [3]. The water washed, water born and water related diseases were due to contaminated groundwater intake by community. The researchers reported that Anemia, Arsenicosis, Cholera, Diarrhea, Fluorosis, Guinea worm disease, Hepatitis, HIV/AIDS, Intestinal worms, Malaria, Schistosomiasis, Trachoma, Typhoidaa were the water born diseases [3-4]. The purpose of this study was to monitor the groundwater quality of Khairpur Mir's, Sindh and comparison with WHO standards.

## 2. EXPERIMENTAL WORK

The sampling was done from ten selected locations of

Ranipur city, Tehsil Sobhodero of District Khairpur Mir's. The Ranipur city situated at 2717'20.040"N and 6830'15.840"E with altitude of 49m. The samples were collected in pre sterilized polyethylene bottles. The standard method of sample collection was followed up [5-7]. The monitoring parameters were pH, TDS, EC, temperature and arsenic content. All the experimental work was conducted in Chemical Engineering Department, MUET Jamshoro.

## 3. RESULTS AND DISCUSSIONS:

The pH of water was the number of concentration of hydrogen ion in water. The pH recommended for drinking water by WHO is in between 6.5-8.5 [9]. All the samples showed the satisfactory limit of pH. Only location 8 and 10 showed bit lower and higher range respectively (Fig 1)

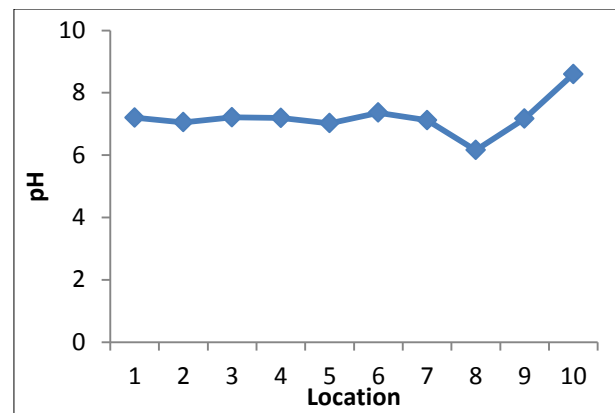

Figure-1: The pH of groundwater of Ranipur city of Khairpur Mir's

The temperature is important parameter in sense that it

\* Assistant Professor, Chemical Engineering Department, MUET Jamshoro  
Email: zeenat.ali@faculty.mueta.edu.pk, zulfiqarbhatti@gmail.com

\*\* Assistant Professor, Energy and Environmental Department, QUEST Nawabshah  
Email: kcmukwana@quest.edu.pk, mureed.tunio@gmail.com



affects the fauna and flora. The higher temperature in groundwater is because of geochemical and geothermal reaction take place under the earth surface. Hence attempt was made to monitor the temperature and it was found in between 30.5- 31.7°C (Fig 2).

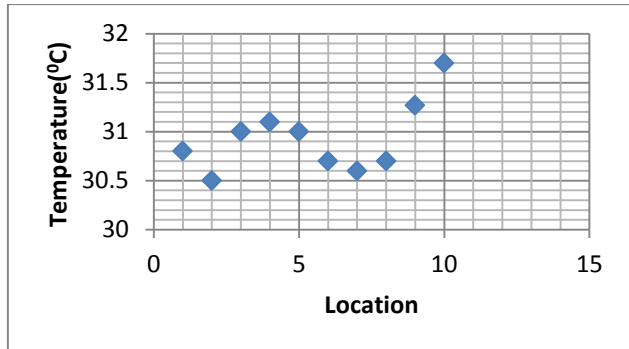

Figure-2: The Temperature of Ground water of Ranipur city of Khairpur Mir's

The quantity of dissolved solids were noted by water proof tester Hanna instruments and expressed in mg/L [12]. According to world health organization (WHO) and Pakistan drinking water standards the allowable limit was <1000mg/L [8-10]. The experimental results showed the TDS level in marked locations was in between 170 to 970mg/L (Fig 3). The results were within the allowable range.

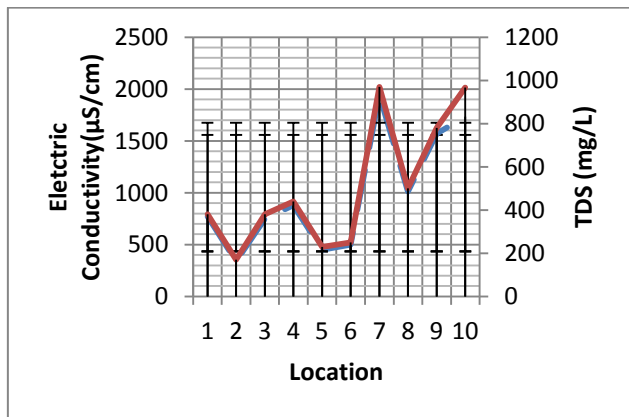

Figure-3: The total dissolved solids (mg/L) content in groundwater of Ranipur city of Khairpur Mir's

The location 7 exhibited the TDS contamination at boundary level. However the low range was found at location 2 and that was 170mg/L. The reason was the strength of population. The location 2 was not thickly populated. The TDS and EC were interrelated terms. According to WHO standards up to 400µS/cm were the recommended level for groundwater [11].The monitored ranged was 340-1940 µS/cm. it was observed that EC ranged was beyond the limit. Only two locations showed satisfactory level out of 10 locations.

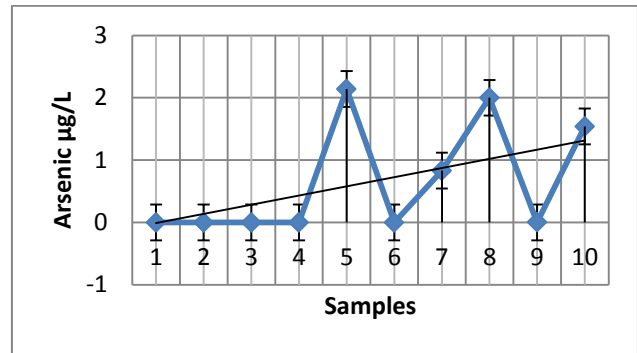

Figure-4. The Arsenic content (µg/L) in Ranipur city of Khairpur Mir's

The Arsenic contamination puts adverse health effect on human being. The Arsenic was determined by kit method (Mercokoquant Arsenic Test). The Kit measures the pentavalent and trivalent arsenic had range from 0.005-0.50mg/L. The ten locations were analyzed shown in Fig 4. The figure portrayed linear trendline with vertical error bars. The location 2 posses were low arsenic contamination that was 0.00001µg/L. The location 5 has high value that was 2.14. Location 1, 3 and 4 have same value. Locations 5, 6, 8, 10 were very high from WHO Standard. WHO Standards value is 0.01 µg/l and Pakistan standard for Arsenic is 50 µg [12].

#### 4. CONCLUSION

The 10 selected locations of Ranipur city of Khairpur Mirs were monitored. It was concluded that TDS level were satisfactory while EC was higher in 8 location. The pH was within ranged however slightly increased in two locations. As for as Arsenic was concerned the range was higher in three location out of ten.

#### ACKNOWLEDGEMENT

The authors are highly thankful to faculty of Chemical Engineering Department for their continuous guidance and support. This work dedicated to Parents for their ever helping.

#### REFERENCES

- [1] M. Karamouz, A.Ahmadi and M.Akhbari (Taylor & francis CRC Press, Boca Raton London New York) 2/e (2011) 4.
- [2] A.Azizullah, M.N Khattak, P.Richter, D.P Häder, Environ Int. 37-2(2010)479.
- [3] M.Ali Zeenat, K.C Mukwana, Hussain Saleem, Samina Saleem and A.J Lagharai, International Jour.of sci. & Eng. Resarch, 6-1(2015)1525.
- [4] R.G. Sinclair, E.L. Jones and C.P. Gerba, Journal of Applied Microbiology, 107-6 (2009) 1769.
- [5] Barwick, R.S., Levy, D.A., Craun, G.F., Beach, M.J. and Calderon, R.L. (2000) Surveillance for waterborne-



disease outbreaks—United States, 1997–1998. *MMWR Surveill Summ* 49, 1–21.

- [6] Parivesh Bhawan (Central Pollution Control Board East Arjun Nagar, Delhi-32) (2007-08) 11.
- [7] U.S. Geological Survey Techniques of Water-Resources Investigations Book 9 Handbooks for Water-Resources Investigations National Field Manual for the Collection of Water-Quality Data( 2006) 19.
- [8] K.F Oyedele, *New York Science Journal* 2-3( 2009)23
- [9] Pakistan Environmental Protection Agency, National Standards for Drinking Water Quality (NSDWQ) (2008)5.
- [10] Scientific and Technological research division (ministry of science & Technology Research division, Government of Pakistan Islamabad) (2010-1011) 15.
- [11] Muhammad Mohsin, Samira Safdar, Faryal Asghar, Farrukh Jamal, *International Journal of Humanities and Social Science*, 3 – 15 ( 2013)114.
- [12] State Water Resources Control Board Division of Water Quality GAMA Program , Groundwater Information Sheet Salinity (2009)17.

# IDENTIFICATION OF UNCONVENTIONAL SHALE-GAS PLAYS AND RESERVOIR CHARACTERIZATION THROUGH $\Delta$ LOGR METHOD AND WELL LOG INTERPRETATION : A CASE STUDY FROM LOWER INDUS BASIN, PAKISTAN

Bilal Aslam\*, Shazia Asim\*, Shabeer Ahmed Abbasi\*\*, Sarfraz Hussain Solangi\*\*\*, Saad Khurshid\*

## ABSTRACT

Unconventional reservoirs mostly consist of fine-grained wealthy with organic shales trapped gas are considered as source, seal, and the reservoir rock. Integration of well logs played an important contribution in evaluation of unconventional reservoirs in order to identify the shale deposited basinward on the basis of their position in Basin, Total Organic Contents (T.O.C), mineralogical composition and reservoir parameters like porosity, saturation, fracture, brittleness, etc. required for optimizing recovery and production of hydrocarbons by integrating of seismic and petrophysical attributes. Seismic data is also used to map the shale gas away from well and identify its distribution with in the basin. In this regard, Passey's method has been used for the identification of T.O.C contents in shale, commonly known as  $\Delta$ logR Method used for assessment of shale gas and depends upon cross plot Gamma Ray (GR), Density (DT) and LLD logs. Using cross plots of GR, DT and LLD Zone with high organic matter (OM) has been identified and integrated with results of petrophysical interpretation of Log to identify Shale Gas of producing fields of Sinjoro Blok, Lower Indus Basin of Pakistan.

## 1. INTRODUCTION

This research work is based on identification of unconventional shale-gas plays and reservoir characterization using petrophysical investigation of logs from Sinjoro block, Lower Indus Basin, Pakistan. Unconventional reservoirs mostly consist of fine-grained wealthy with organic shales trapped gas are considered as source, seal, and the reservoir rock. Integration of well logs played an important contribution in evaluation of unconventional reservoirs in order to identify the shale deposited basinward on the basis of their position in Basin. Source shales have also been proved to be good reservoir rock though they have tight-porosity, low-permeability and certain quantity of silt. Analysis of source rock parameters is mainly based on organic carbon, maturation of organic matter, geochemical and geophysical parameters in order to find closure for reservoir. The organic carbon of source rock has specific velocity, density and resistivity characteristics which affect log and seismic responses. Thus, source-shale's and shale-gas reservoirs can be analyzed through logs. In this paper, application of integrated well log interpretation techniques has been applied on shale-gas plays of producing fields of Sinjoro Block, Lower Indus basin of Pakistan [1-2].

## 2. GEOLOGICAL SETTING OF THE AREA

The study area is the part of Sinjoro Block located in Lower Indus Basin of Pakistan.. Several Oil and Gas fields were discovered in Lower Indus Basin. Lower Indus is characterized by extensional tectonics [3-6]. Tilted faults have been resulted due to the extensional tectonic in the Cretaceous with in and surroundings of the study area. The deposition of the reservoir Lower Goru sandstones and interbedded source rocks took place in a passive margin region formed during the rifting of the Indian plate from the eastern margin of Africa during the break up of Gondwanaland. Figure 1 is showing Generalized Stratigraphic Cross section of Lower Indus Basin [7-9]

Many of the discoveries from Lower Goru have been successful (Ahmed et al., 2004). Sembar Formation and Interbedded Shale of Lower Goru are proved source rock [10-12] discussed the Shale Gas potential in Central and Lower Indus Basin. Lower Goru sands are considered as Proved Reservoir Rock of Indus Basin. Various Nomenclatures are used for Lower Goru Formation. [6] [9-10] discussed various nomenclature used for description Lower Goru Formation. In this paper "C Sand", the OMV classification of Lower Goru is taken into account which is equivalent to Albian Age. A depth structure map on top of Lower Goru Formation showing drilled wells shown in Figure 2.

---

\* Department of Earth Science Quaid-e-Azam University, Islamabad

\*\* Oil and Gas Development Company Limited, Islamabad.

\*\*\* Centre for Pure and Applied Geology, University of Sindh, Jamshoro

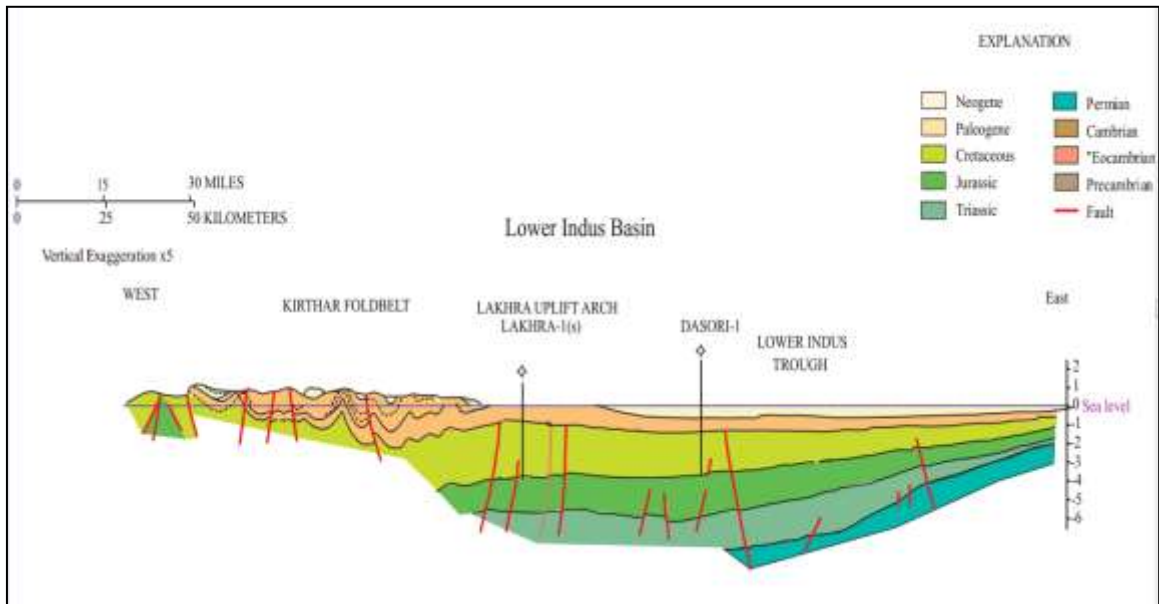

Figure-1: Generalized Cross section of Lower Indus Basin (Kadri, 1995)

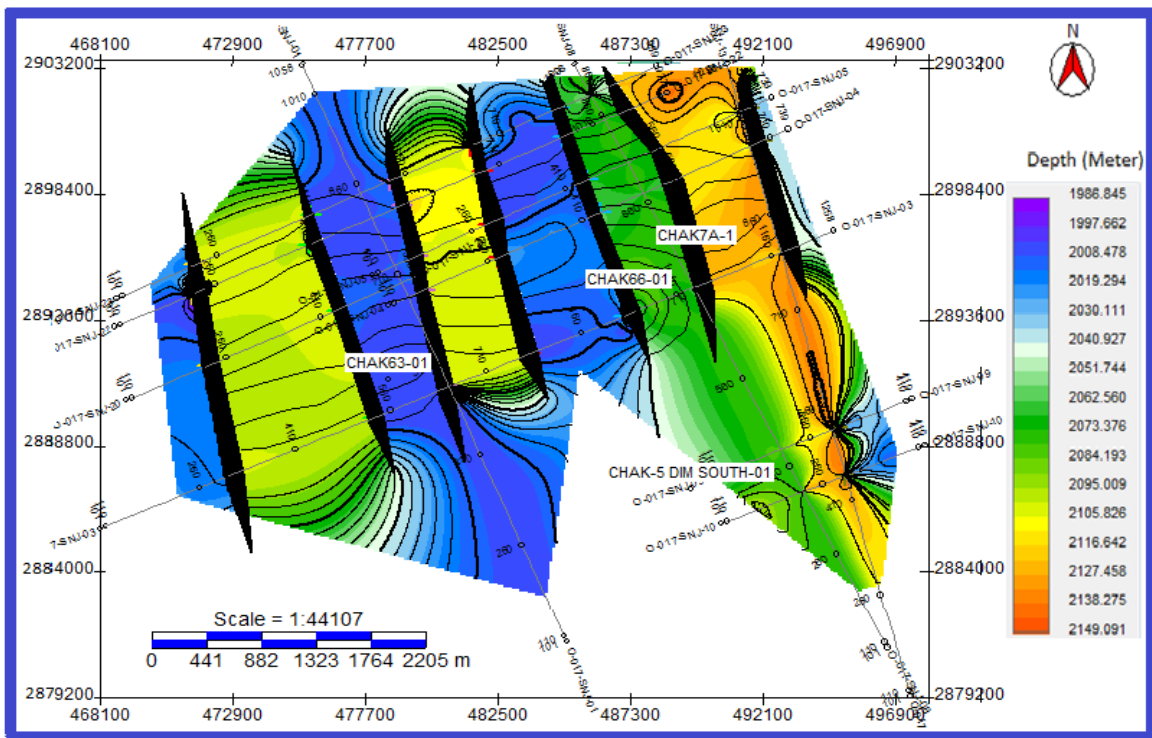

Figure 2: Depth contour map of Lower Goru Formation

### 3. PETROPHYSICAL INVESTIGATION

All kind of studies carry out to study subsurface data of well using wireline log motifs is called as Petrophysical studies. Such study involves conventional study of formation and specialized study and Advance Studies using specific tools and techniques. Conventional logs (GR , Resisitvity , Sonic , Neutron Porosity and Density

log to determine lithology , Porosity, Shale Volume , Water Saturation and contents of moveable and immoveable Hydrocarbons. Calculation of TOC content using Porosity Logs (Sonic, Density) and Resistivity logs is called as specialized study. TOC study involves calibration of values with lab data for precise data. While Elemental Composition Spectrometry (ECS), FMI Imaging are advance tools to study composition of

minerals and subsurface bedding plane character respectively.

### 3.1 CONVENTIONAL PETROPHYSICAL STUDY

Different logs have been used in order to identify the shale sequences. One of the most common cross plot is the RHOB, LLD and GR log cross plot. This cross plot is used in petrophysical analysis for lithology determination and its sequence. Porosity is relatively invariant in different lithology like quartz with shale or calcite. The cross plots are prepared for the reservoir zone of Lower Goru Formation for different wells of Sinjhora area. The three polygons indicate the lithology variation of Lower Goru and result shows that the formation mainly consists of sand shale sequence with mostly Sandy Shale lithology. CHAK 66-01 cross plot ranges from depth 2000m to 3050m and indicates that the formation mainly consist of shaly sand with bottom part of formation have shale. Only clean sand part is between 2850m to 2900m (Figure 3). CHAK-5 DIM SOUTH-01 cross plot ranges from depth 2050m to 2900m and indicates that the whole formation have shaly sand with a small lense of sand at depth 2870m to 2885m (Figure 4).

After plotting the log curves of wells (Figure 5, 9) Petrophysical results of CHAK 66-01 shows that also there are clean sand in Zone-A because of low shale value and high matrix value indicated but water saturation increases in this zone and hydrocarbon is less in this zone (Figure 6), while Zone-B is mainly based on Sandy Shale and it have good effective porosity with few amount of hydrocarbons are also present which may be recovered (Figure 7) and Zone-C has more Shale sequence than

Sand but lower part in this zone has sand packages which also have fair amount of hydrocarbon (Figure 8).

Petrophysical result of CHAK-5 DIM SOUTH-01 shows that Zone-A has good amount of hydrocarbon present at different depths (Figure 10). Mainly 2020m to 2035m where saturation of hydrocarbon is almost 45% and have high sand lithology with almost 90% while its effective porosity is 10% other productive zone in Zone-A is starting from 2180m to 2200m where saturation of hydrocarbon is 45% and have high sand lithology with almost 90% while its effective porosity is 15%. Lower part of this zone starting from 2240m to 2300m also can be very productive as saturation of hydrocarbon is almost 45% and have high sand lithology with almost 90% while its effective porosity is 15%. Zone-B of starting from 2300m to 2600m which have higher amount of hydrocarbon throughout this zone. Lower part of this zone have high amount of shale (Figure 11) and have high amount of hydrocarbon and high porosity as well which means that either this indicates hydrocarbon in shale which needs to study further as shale gas or its data issues. Caliper log shows high deflection in this zone which means that the zone of invasion is high which may act as error for log recording. But if it's tight gas then this whole zone may act as productive zone and Zone-C has higher amount of shale but at few depths sand packages found (Figure 12). So by and large this zone cannot said to be as productive zone but at the lower part of this zone at depth 2790m to 2850m a large sand package is identified which indicates good amount of hydrocarbon with good porosity.

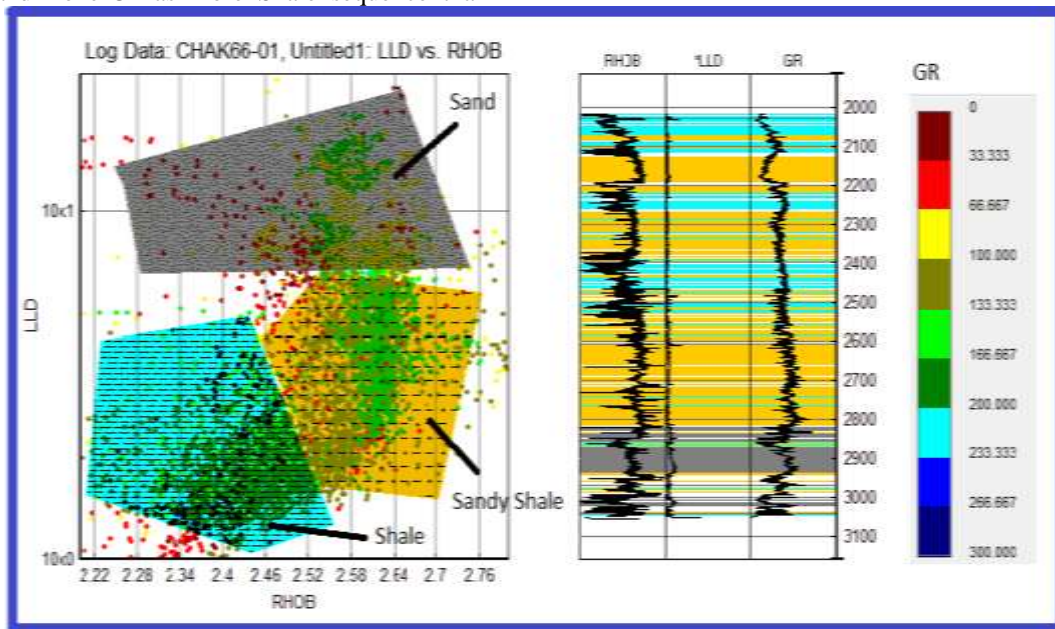

Figure-3: Facies analysis of CHAK 66-01

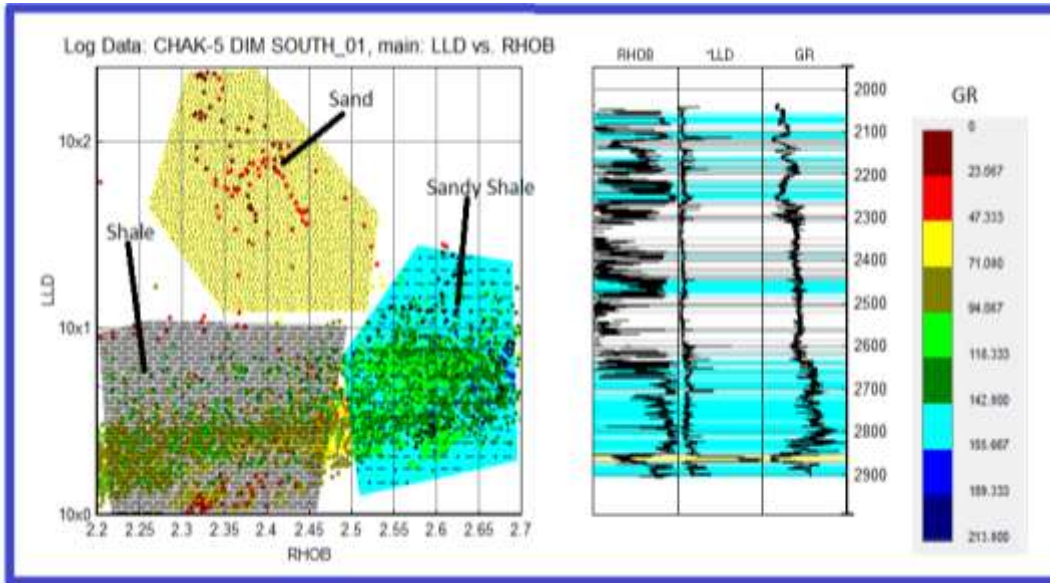

Figure-4: Facies analysis of CHAK-5 DIM SOUTH-01

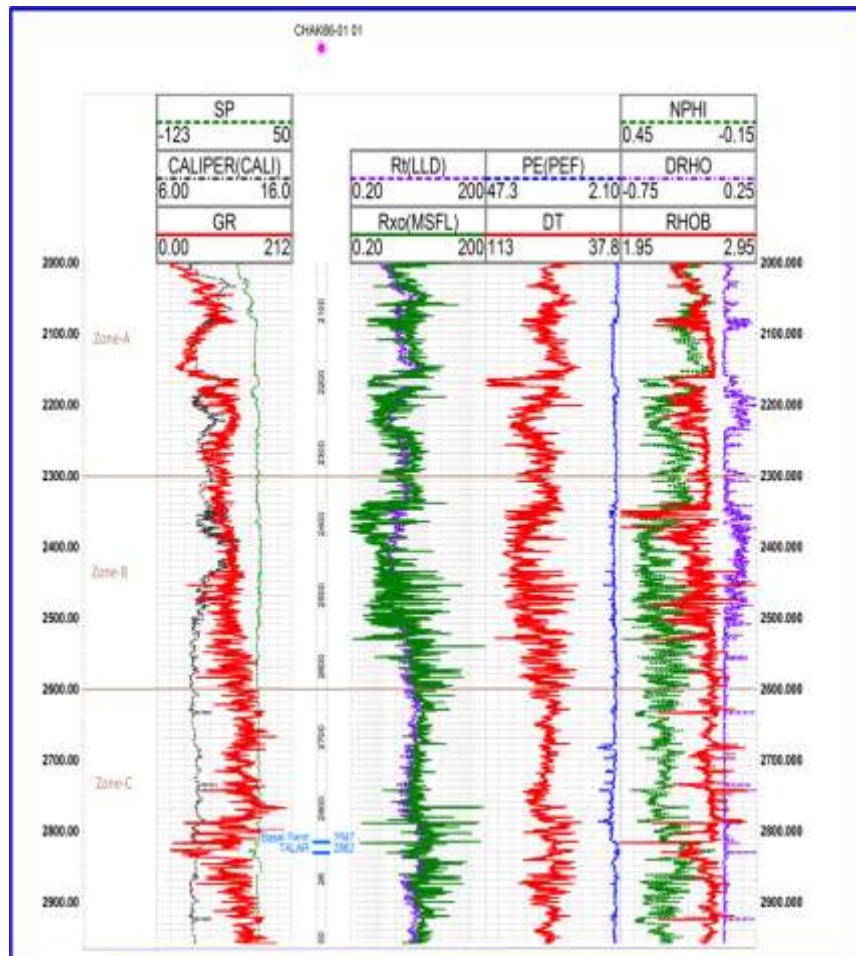

Figure-5: Well log data of CHAK 66-01



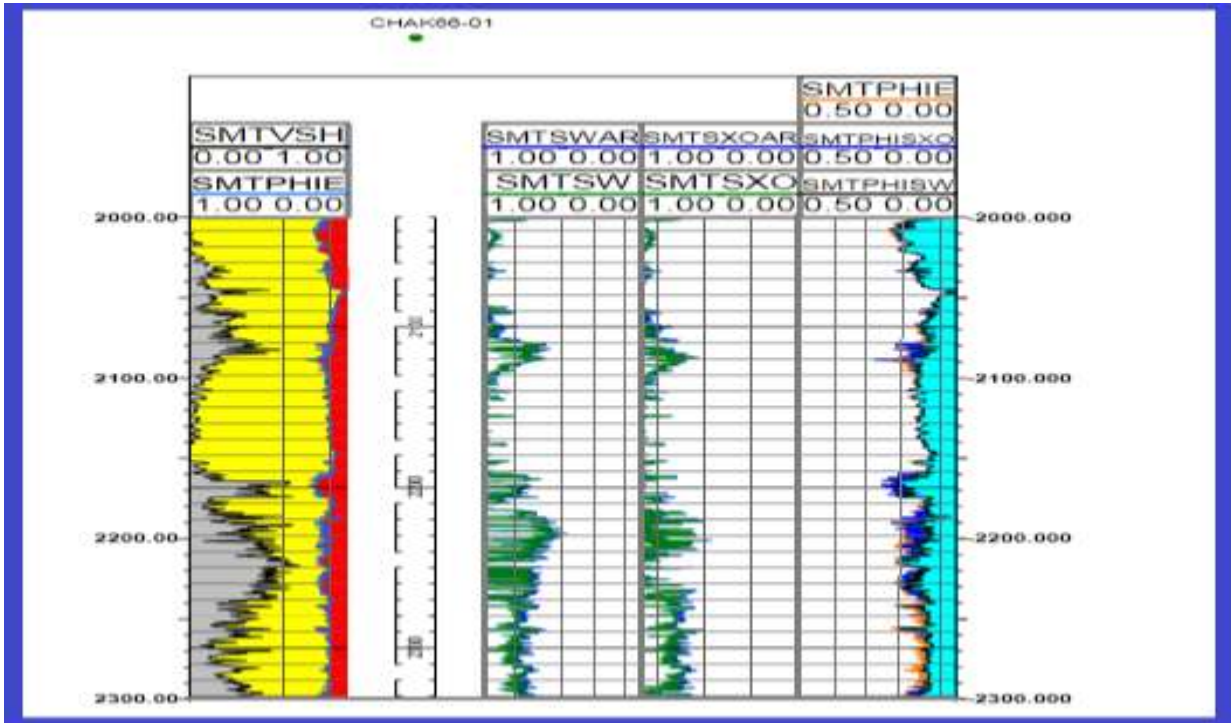

Figure-6: Petrophysical Results of Zone-A of well CHAK 66-01

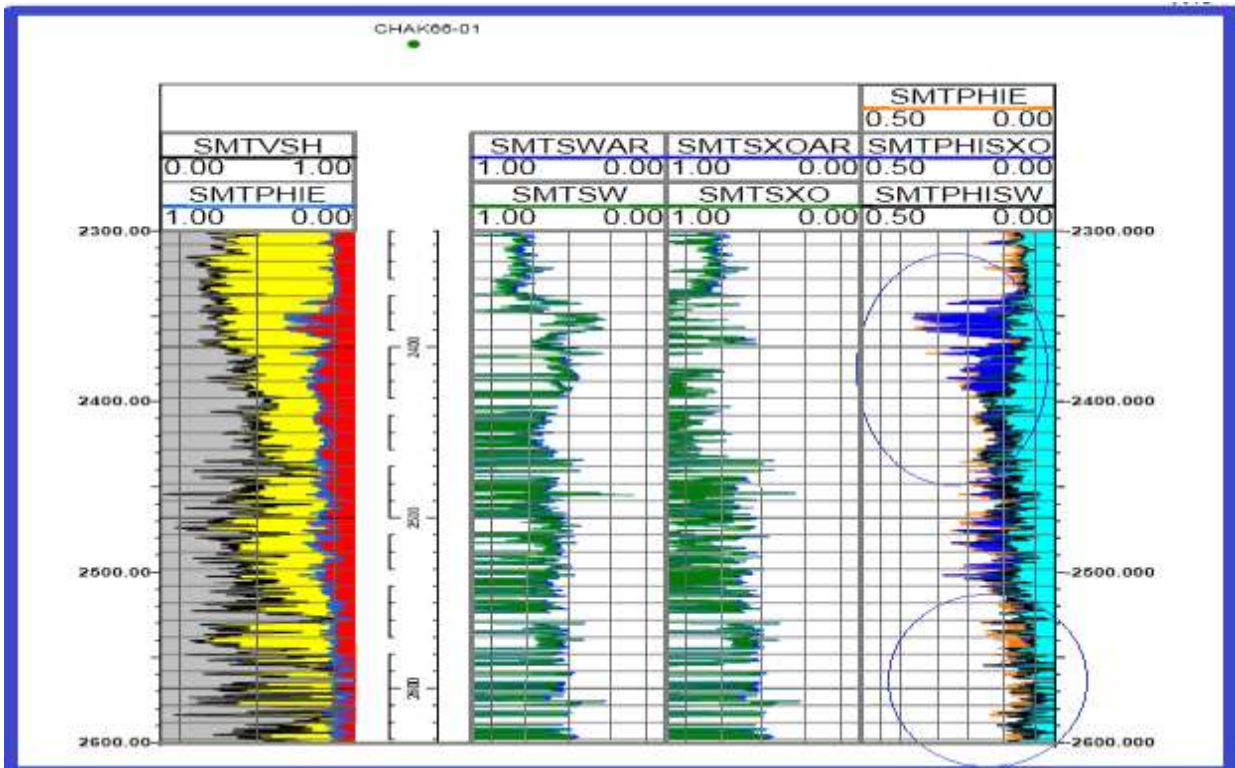

Figure-7: Petrophysical Results of Zone-B of well CHAK 66-01



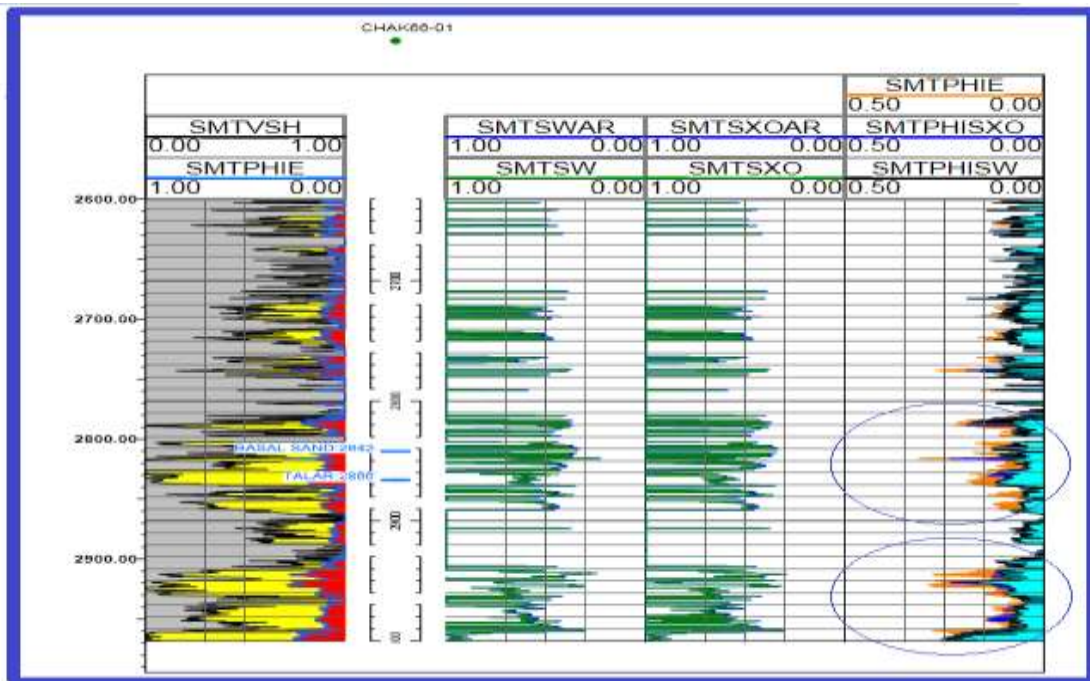

Figure 8: Petrophysical Results of Zone-C of well CHAK 66-01

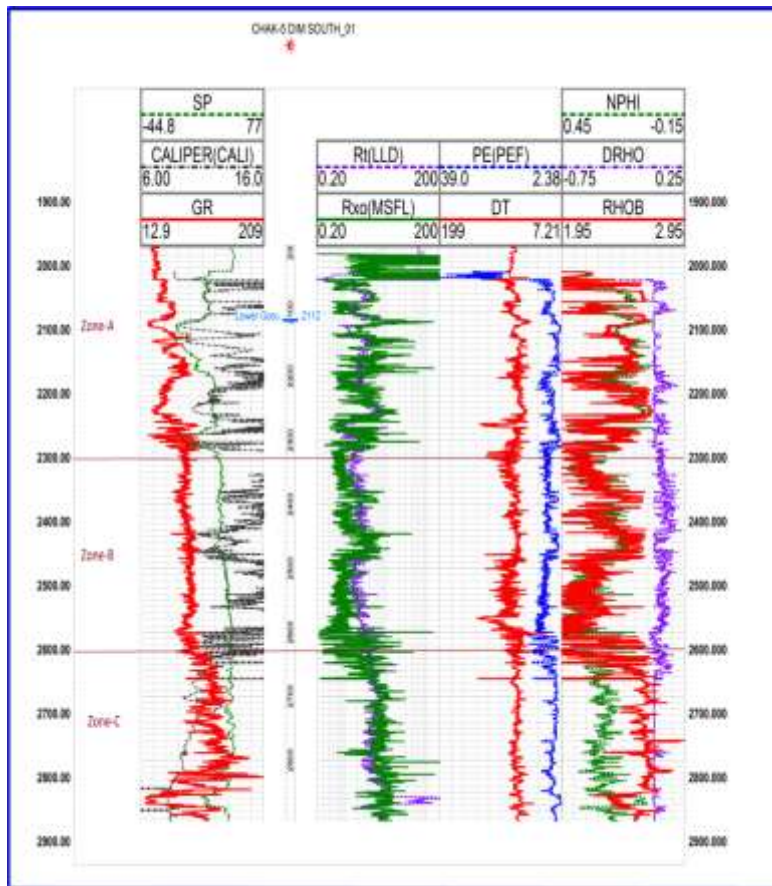

Figure 9: Well log data of CHAK-5 DIM SOUTH-01

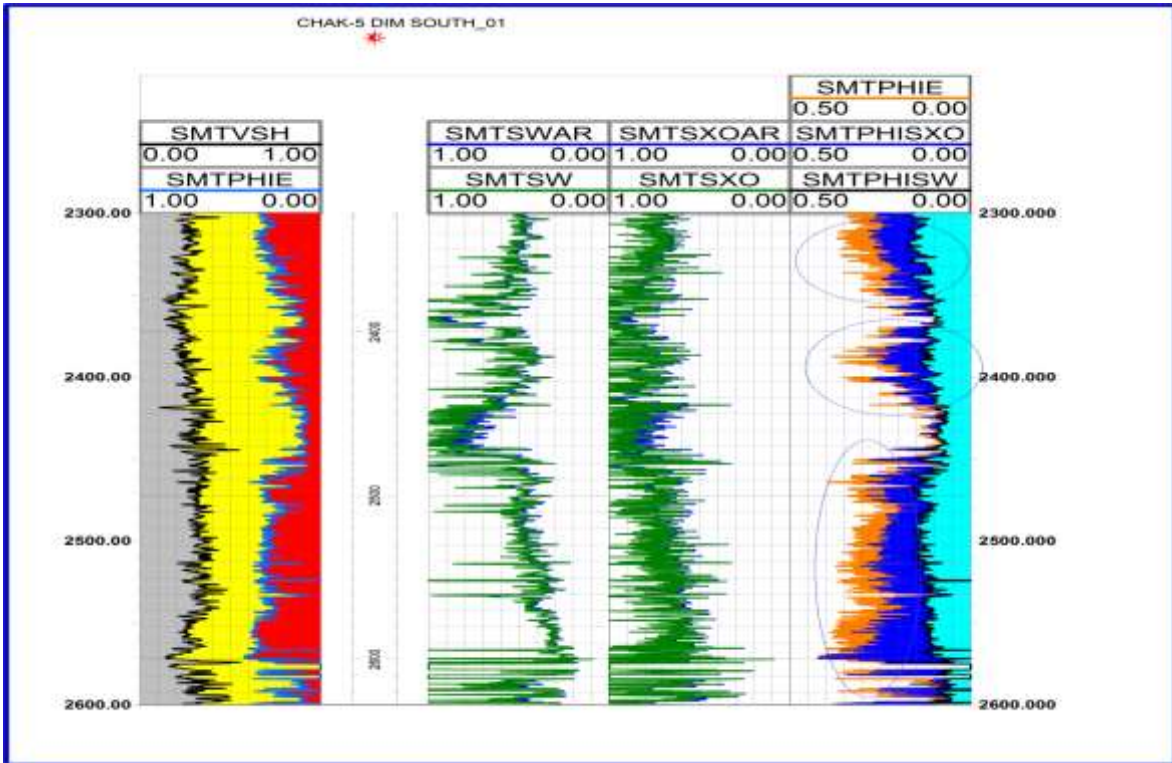

Figure-10: Petrophysical results of Zone-A of CHAK 5 DIM SOUTH-01

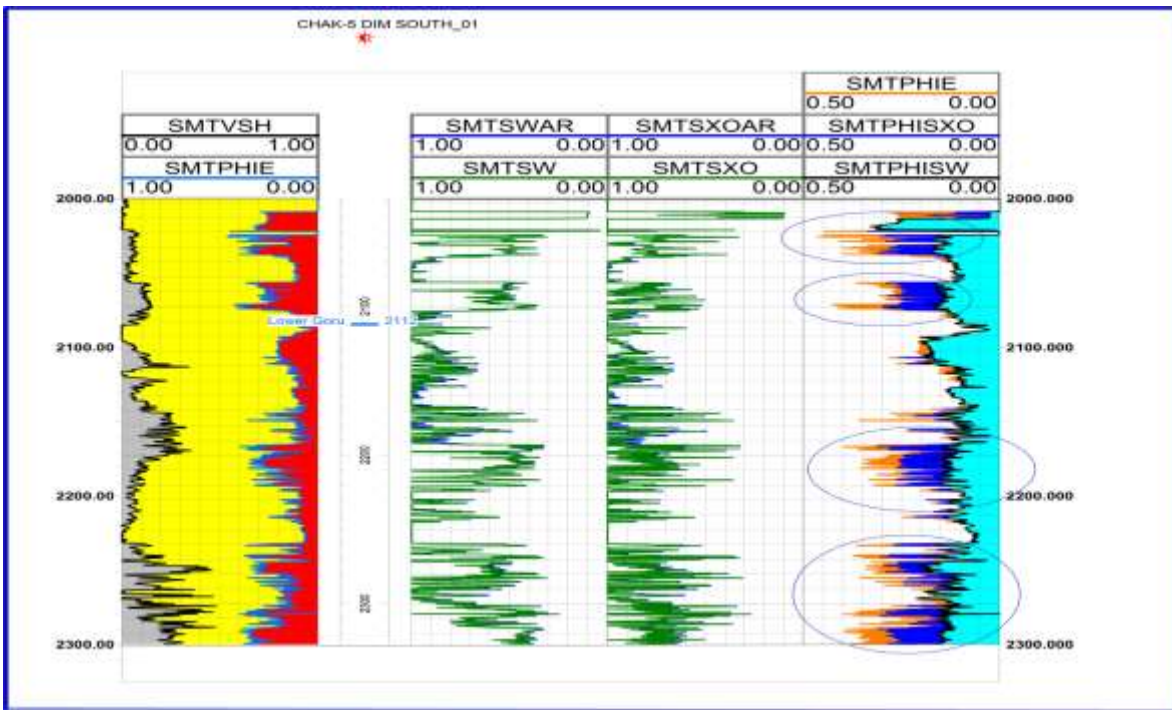

Figure-11: Petrophysical results of Zone-B of CHAK 5 DIM SOUTH-01

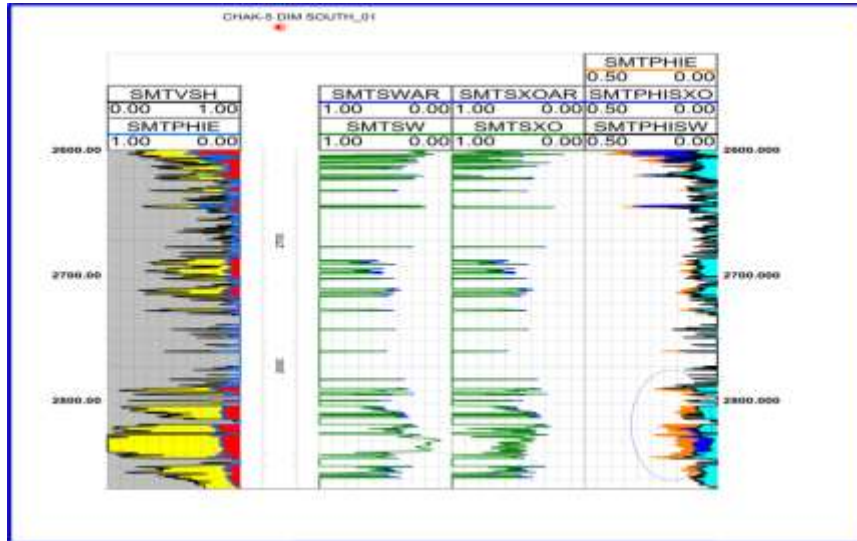

Figure-12: Petrophysical results of Zone-C of CHAK 5 DIM SOUTH-01

### 3.2 Cross Plots of Deep Resistivity and Sonic

Basic theme behind the  $\Delta\log R$  Interpretation is developed by [13-14] and based on assumption that shale's and lime-mudstones contains significant amount of OM (organic Matter) and Non source rocks (sandstone, Limestone) also contains OM but not in significant amount.  $\Delta\log R$  is separation between resistivity and porosity logs (Sonic, Neutron and Density) and bears primary relationship between TOC and  $\Delta\log R$ ;  $\Delta\log R$  separation increases, value of TOC also increases. However Resistivity Deep Log (LLD) and Sonic (DT) is considered as best combination to calculate  $\Delta\log R$ . The best description of the method is also posted on the online magazine Search and Discovery, in "Direct Method for Determining Organic Shale Potential from Porosity and Resistivity Logs to Identify Possible Resource Plays [15-16]. Crossplots should be constructed keeping GR values in

mind because it will prove the shale presence. Hence at those depths where DT, LLD and GR log show high values may confirm the rich organic shale content. Crossplots should be constructed keeping GR values in mind because it will prove the shale presence. Hence at those depths where DT, LLD and GR log show high values may confirm the rich organic shale content. Therefore cross plot of DT vs LLD has been carried for Chak-63-01 and Chak 5 Dim South-01 (Fig-13 and Fig 14). Such cross plot also shows that there are zones where DT value and LLD shows high values in petrophysical identified hydrocarbon bearing zones. This shows that organic enrichment (Figure 13) is present in shaly sand (depths 2300m to 2500m) of CHAK 66-. Similarly Chak 5-Dim South-01 also shows presence of organic shale plays at depths of 2600m to 2900m (Figure 14). Hence it is also proved that Shale and also these zones may be explored as 'Shale Gas.

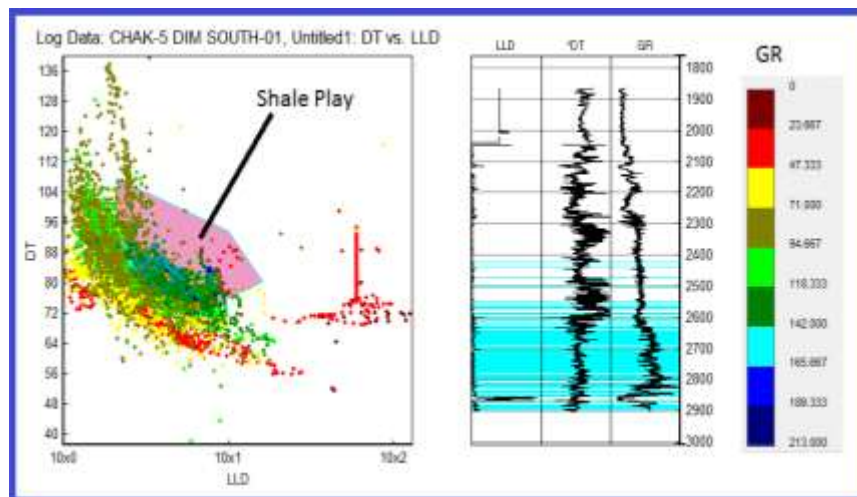

Figure-13: Crossplot of DT vs LLD and Shale play of CHAK 63-01



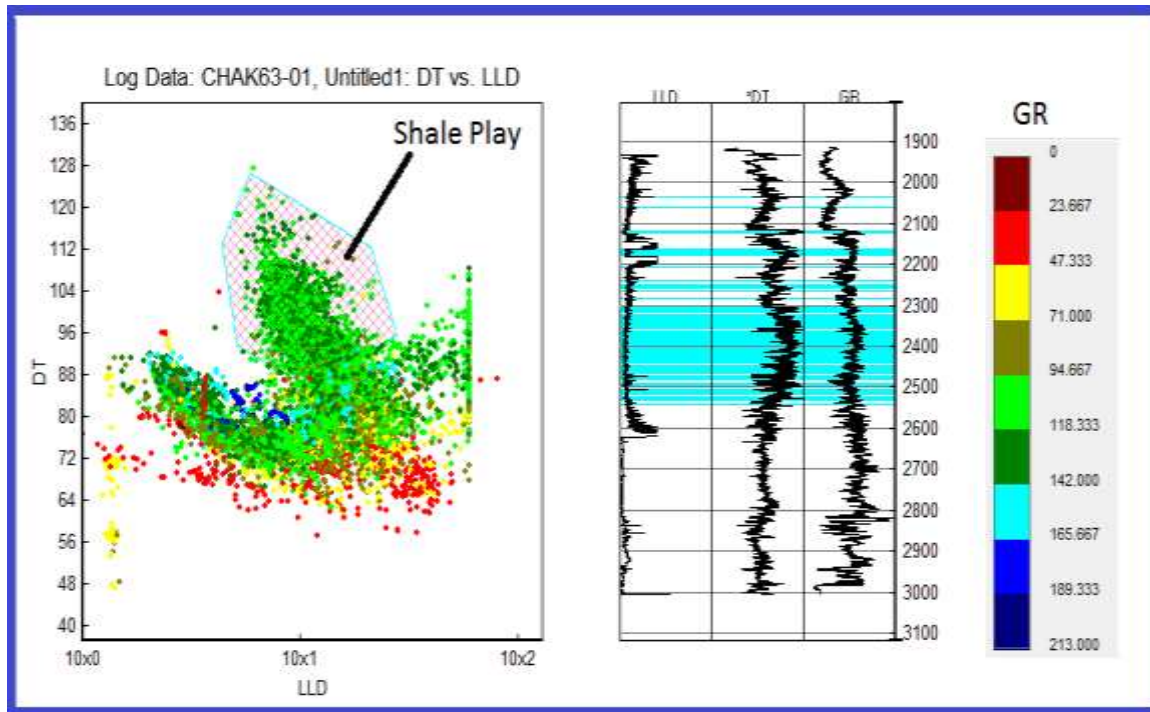

Figure 14: Crossplot of DT vs LLD and Shale play of CHAK 5 DIM SOUTH-01

#### 4. CONCLUSIONS

Petrophysical results of CHAK-5 DIM SOUTH-01 shows that Zone-A has good amount of hydrocarbon present at different depths. Mainly 2020m to 2035m where saturation of hydrocarbon is almost 45% and have high sand lithology with almost 90% while its effective porosity is 10% other productive zone in Zone-A is starting from 2180m to 2200m where saturation of hydrocarbon is 45% and have high sand lithology with almost 90% while its effective porosity is 15%. Lower part of this zone starting from 2240m to 2300m also can be very productive as saturation of hydrocarbon is almost 45% and have high sand lithology with almost 90% while its effective porosity is 15%. Zone-B of starting from 2300m to 2600m which have higher amount of hydrocarbon throughout this zone. Lower part of this zone have high amount of shale and have high amount of hydrocarbon and high porosity as well which means that either this indicates hydrocarbon in shale which needs to study further as shale gas or its data issues. Caliper log shows high deflection in this zone which means that the zone of invasion is high which may act as error for log recording. But if it's tight gas then this whole zone may act as productive zone and Zone-C has higher amount of shale but at few depths sand packages found. So by and large this zone cannot said to be as productive zone but at the lower part of this zone at depth 2790m to 2850m a large sand package is identified which indicates good amount of hydrocarbon with good porosity. Similarly Chak 5-Dim South-01 also shows presence of organic

shale plays at depths of 2600m to 2900m (Figure 14). Hence it is also proved that Shale and also these zones may be explored as 'Shale Gas

#### REFERENCES

- [1] Bruce Hart, Colin M. Sayers, and Alan Jackson, 2011, an introduction to this special section: Shales, *The Leading Edge* 30, 272-273.
- [2] Yaping Zhu, Enru L., Alex M., Michael A. P., and Christopher E. H., 2011, Understanding geophysical responses of shale-gas plays, *The Leading Edge* 30, 332-338.
- [3] Wandrey, C.J., Shah, H.A., 2004. Sember-Goru/Ghazij, Composite total petroleum system, Indus and sulaiman-kirthar geologist provinces, Pakistan and India. United States Geological surveys open file report, Bulletin, 2208-C.
- [4] Memon, A.D., Siddiqui, I., and Memon, A.A., 1999, "Tectonic of Sindh Monocline, Pakistan and Their Effects on Hydrocarbons", *Mehran University Research Journal of Engineering & Technology*, Volume 18, No 10, pp. 38-39, 87-94, Pakistan, 1999.
- [5] Zaigham, N.A., Maliick, K.A., 2000. Prospect of hydrocarbon associated with fossil rift structure of the southern Indus basin, Pakistan. *Association of Petroleum geologist Bulletin*, 84, 18-21.
- [6] Ahmad, N., Fink P., Sturrock S., Mahmood T. and Ibrahim M., 2004, Sequence stratigraphy as predictive tool in Lower Goru fairway, Lower and Middle Indus Platform, Pakistan. *Proceedings, /Pakistan Association*

of Petroleum Geoscientists (PAPG)/ Society of Petroleum Engineers (SPE) Annual Technical Conference, Islamabad, Pakistan.

- [7] Kadri, I., B., 1995. Petroleum geology of Pakistan: Karachi, Pakistan, Pakistan Petroleum Limited, 275.
- [8] Kemal, A., Balkwill, H.R., Stoakes, F.A., 1991. Indus Basin hydrocarbon plays, New directions and strategies for accelerating petroleum exploration and production in Pakistan: Proceedings of an international petroleum seminar, Ministry of Petroleum and Natural Resources, Islamabad, Pakistan.
- [9] Copestake, P., Cooper, B.A., Slatford, M., Vanstone, S., Maqsood, T. and Ashraf, M., 1995, Sequence stratigraphy of the Upper Jurassic-Mid Cretaceous of the Indus Basin, Pakistan and Rajasthan Area of India, Proceeding of International Symposium on Sequence Stratigraphy in SE Asia.
- [10] I.E.D.S., 1995, A sequence stratigraphic study of the Lower Goru – Sembar Formations of Lower and Middle Indus Basins of Pakistan and Rajasthan: Multiclient study.
- [11] Nazeer, A., Solangi, S.H., Brohi, I.A., Usmani, P., Napar, L.D., Jhangir, M., Hameed, S. and Manshoor, S.M, 2012-2013, Hydrocarbon Potential of Zinda Pir Anticline, Eastern Sulaiman Foldbelt, Middle Indus Basin, Pakistan, Pakistan Journal of Hydrocarbon Research, Vol. 22 & 23, (June 2012 & 2013)
- [12] Abbasi, S.A., A. Nazeer, S.H. Solangi, 2015, An overview of structural style, petroleum geology and hydrocarbon potential of Jabo Field, Southern Sindh Monocline, Pakistan. Sindh Univ. Res. Jour. (Sci. Ser.) Vol.47 (1):37-424
- [13] Roger M. Slatt and Younane Abou Sleiman Merging sequence stratigraphy and geomechanics for unconventional gas shales, The Leading Edge 30, 2011, 274-282.
- [14] Q. R. Passey, S. Creaney, J. B. Kulla, F. J. Moretti, and J. D. Stroud. A practical model for organic richness from porosity and resistivity logs, AAPG Bulletin; December 1990; v. 74; no. 12; p. 1777-1794.
- [15] Thomas Bowman, "Direct Method for Determining Organic Shale Potential from Porosity and Resistivity Logs to Identify Possible Resource Plays, Article #110128, June 14, 2010.
- [16] Thomas Bowman, Direct Method for Determining Organic Shale Potential from Porosity and Resistivity Logs to Identify Possible Resource Plays, AAPG Annual Convention, New Orleans, LA, April 11-14, 2010.
- [17] Amie M. Lucier, Ronny Hofmann, and L. Taras Bryndzia, 2011, Evaluation of variable gas saturation on acoustic log data from the Haynesville Shale gas play, NW Louisiana, USA, The Leading Edge 30, 300-311.

# CONTINUOUS WAVELET TRANSFORMS FOR DELINEATION OF THIN SAND RESERVOIRS OF MIANO AREA, SOUTHERN INDUS BASIN, PAKISTAN

Muhammad Tayyab Naseer\*, Shazia Asim\*\*\*, Shabeer Ahmed Abbasi\*\*\*, Sarfraz Hussain Solangi\*\*\*\*  
Faisal Munawar\*\*\*

## ABSTRACT

This research endeavor to provide a workflow that may open the ways to explore the clastic reservoirs by the application of continuous wavelet transform technique of spectral decomposition and conventional seismic attributes such as average energy, reflection strength to a 3D seismic data set of Miano gas field, Lower Indus Basin of Pakistan. Miano Gas field is one of the distinct hydrocarbon producing zone located in Lower Indus Basin, Pakistan. Lower Goru is the principal hydrocarbon reservoir of Fluvial-deltaic depositional environments. Extensive geophysical studies have been done in this area to explore these clastic reservoirs. Predicting the thin reservoir sands within these laterally heterogeneous environments is a challenge for the Geoscientists. To overcome this issue, we have applied spectral decomposition; a vigorous seismic interpretation tool for delineating the channel geometries and the potential thin beds of hydrocarbon bearing sands. This technique can detect thin gas sand reservoirs which conventional seismic attributes cannot do due to their bandwidth limitations. Average energy could only give clue for these depositional features due to bandwidth limitation. However, continuous wavelet transform technique of spectral decomposition has remarkably delineated the channel geometries and the thin gas sand beds associated with these depositional features. Therefore, continuous wavelet transform in conjunction with some conventional seismic attributes can be used for future delineation and characterization of Fluvial-Deltaic reservoirs by giving optimal well locations of Miano area, Lower Indus Basin, Pakistan.

**Keywords:** CWT-Spectral Decomposition, Seismic attributes, Fluvial-deltaic sands.

## 1. INTRODUCTION

Fluvial-deltaic clastic reservoirs are becoming the focus of interest in the exploration of hydrocarbons. As these reservoirs are the combinations of various stratigraphic traps in the form of stacked channel sands. Lower Goru is one of the distinct clastic reservoirs of Miano Gas field Lower Indus Basin of Pakistan that has been producing the hydrocarbon for the last few decades. Many extensive geophysical studies have been carried on this area with the object to explore these clastic reservoirs. The complex fluvial dominated deltaic depositional environments acts as a barrier to successfully detect and delineate the reservoirs in perspectives of lithology and the hydrocarbon prospecting which is always remained a challenge for the Geoscientist. These sand systems consist of an organization of thick gas sand prone geometries such as point bars together with the levees and overbanks deposits.

The practical implications for characterizing these clastic reservoirs is that the crevasse, levees and point bars are the excellent geometries for hosting the hydrocarbon

producing sands which can be delineated through various advance seismic interpretation tools. The aim of the research is to provide a workflow by the application of continuous wavelet transform technique of spectral decomposition (CWT-SD) to detect and delineate the thin sand reservoirs to a 3D post stack seismic data set of the area.

The prime objectives of this research work is to execute spectral decomposition as a key seismic interpretation tool for possible lithology and hydrocarbon producing zones detection through thin reservoir delineation. We have also incorporated average energy and (Instantaneous amplitudes) reflection strength attribute as a lithology indicator, but, we our focus remained on CWT-SD tool for possible thin reservoirs delineation.

Earlier in the same area we have applied seismic attributes and spectral decomposition for relatively thin. There is variety of spectral decomposition techniques with different applications. Each technique has its own advantages and disadvantages [1]. However, in theory, CWT-SD technique have proved it's excellent ability for

---

\* Department of Earth Sciences, Quaid-e-Azam University, Islamabad, Pakistan.

\*,\*\* Institute of Geomatics and Geophysics, China University of Geosciences, Hubie, Wuhan, China.

\*\*\* Oil and Gas Development Company Limited, Islamabad, Pakistan (Corresponding Author)

\*\*\*\* Centre for Pure and Applied Geology, University of Sindh, Pakistan.



providing the image with high resolution as it is out of bound for pre-selecting the time window length and does not have predetermined time – frequency resolution [2]. The suggested design of study can be helpful for delineating the remaining hydrocarbon potential sand reservoirs in the area.

## 2. GEOLOGICAL SETTING OF AREA

The dominantly north-south–trending Indus Basin is bounded by the Indian shield to the East, the Kohat Potwar Plateau to the North, and the fold and fault belts of the Sulaiman and Kirthar ranges to the West (Fig. 1) [3]

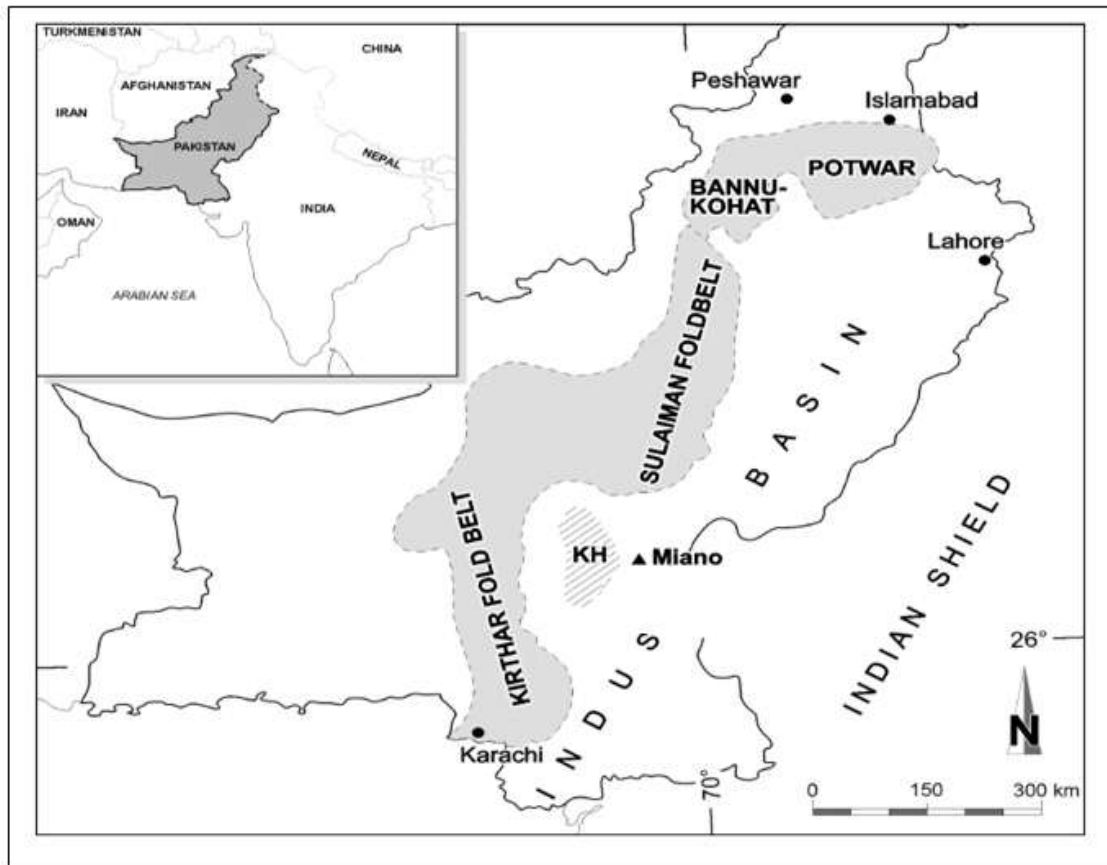

Figure-1. Map of Pakistan Showing Miano Gas Field.

The major structures and sedimentology of the Lower Indus Basin are rifting of the Indian Plate from Gondwanaland (Jurassic or Early Cretaceous) which probably created NE-SW to N-S rift systems, isostatic uplift or ridge-push at the margins of the newly developed ocean probably caused uplift and eastwards tilting at the start of the Cretaceous. Separation of the Madagascan and Indian plates in the Middle to Late Cretaceous may have caused some sinisterly strike-slip faulting in the region and hotspot activity and thermal doming at the Cretaceous-Tertiary boundary [4-5]. This in turn caused uplift, erosion, extrusion of the Deccan flood basalts and probably the NNW-striking normal faults.

### 2.1 Depositional Environments and Reservoir Characteristics

The dominant lithology is medium to coarse-grained sandstones of shallow-marine setting which constitute the

major hydrocarbon producing reservoirs in Miano gas field. There is a variety of reservoirs characterized by deposits of a proximal wave-dominated delta system of fluvial-deltaic and barrier-bar complex with a variety of sub environments. Organic-rich shales within the Sembar Formation are the main hydrocarbon source rock for the lower and middle Indus basins [6].

Lower part of Lower Goru Formation is already producing gas, which is further divided into four sand sequences as shown in (Fig.2 A, B, and C and D) [7]. Predominantly gas-saturated Pay sands, These sands show anomalously high porosities and permeabilities at high temperatures and depths of are lying in the depths intervals between (1900m to 3800m) with average absolute porosities, are 16%, reaching more than 35%, are mostly encountered within mainly thin fluvial-deltaic sand systems.

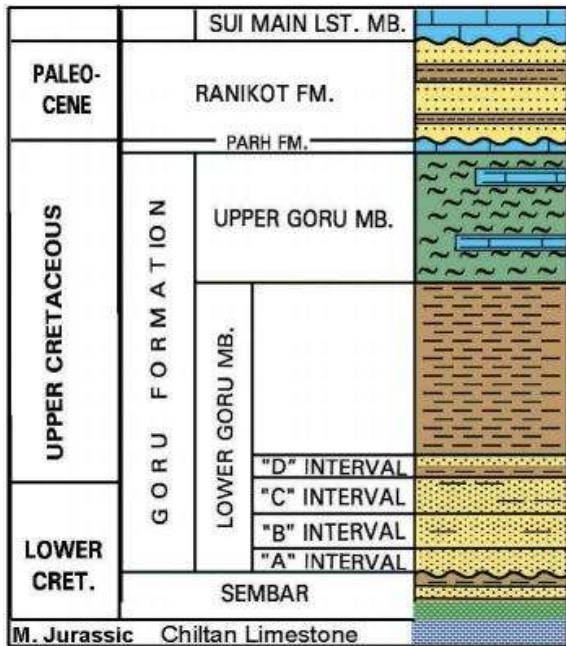

Figure-2. The Stratigraphic Column showing the subdivisions of Lower Goru Formation into Sand intervals A, B, C and D [7].

### 3. DATASET AND METHODOLOGY

The area is one of the leading hydrocarbon gas producing fields of Southern Pakistan. The used volume covers an area of 450 Km<sup>2</sup> of Miano gas fields which was acquired in vintage 1999. This volume is divided into 340 Inlines and 450 cross lines which were used for this research work. The data was sampled at 2ms. Vibroseis energy source was used for the data acquisition. Data of six wells has been utilized for this research work.

Synthetic seismograms were generated for wells to link logs (in depth domain) to time domain seismic data and to observe the seismic character of sands within the area. Well to seismic ties were performed by establishing correlation between the seismic and synthetic seismograms by adjusting T-D functions through stretch and squeeze method (Fig.3). The zone of interest lies between 1.55 s to 1.68s (3000m to 3350 m) window of the reservoir zone.

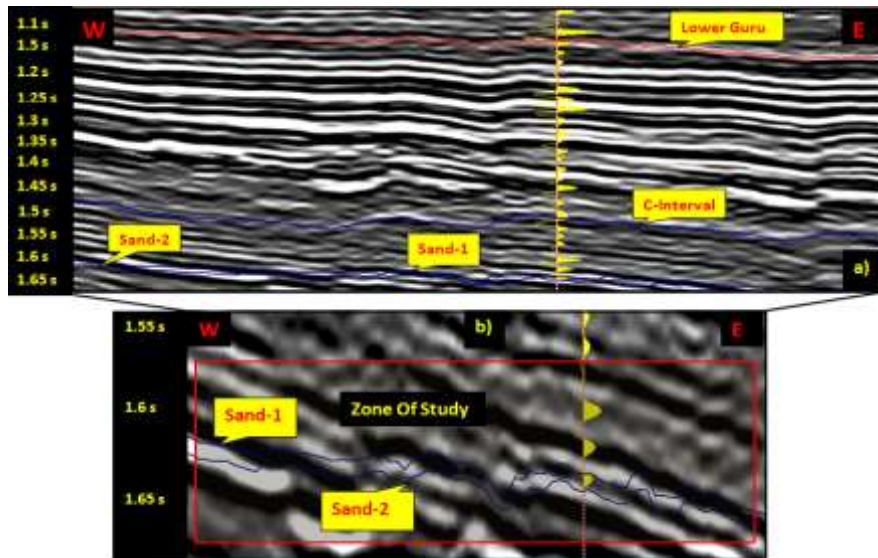

Figure-3. a. The Conventional Seismic Section and Zoomed Section at Reservoir level of interest

b. Yellow Wiggles is the Traces of Synthetic Seismogram.

Two horizons namely Lower Goru and informally nomenclature C-Interval have been marked. It is important to mention here that two surfaces have projected and named as Sand-1 and Sand-2 by taking the reference of Lower Goru horizon for the purpose of visualizing the depositional features at the reservoir level.

Spectral decomposition is a tool for enhanced imaging and mapping chronological bed thickness using 3D

seismic data [8] and it aids in seismic interpretation by analyzing the variation of amplitude spectra. There is a Variety of spectral decompositions methods. Each method has its own advantages and disadvantages and different applications require different methods [1]. The aim of all these methods is to decompose a seismic signal into its constituents in order to achieve better geological information. For instance, the discrete Fourier transform

is a traditional frequency decomposition method. The transform determines the relative strength of each frequency component of the entire signal but does not provide information on how the frequency content changes with time. Therefore, the discrete Fourier transform method is not suitable for analysis of non-stationary signals since it is unable to localize frequency variations over time.

Therefore, in this study, we have applied CWT- SD on full stack high resolution 3D seismic data to check the frequency response of fluvial-deltaic sands and calculated iso-frequency volumes using the output spectra of spectral decomposition of CWT for analysis of reservoir sands of various thicknesses. However, theoretically, CWT technique have better ability to provide the image with high resolution as it does not restricted to the pre-selection of the time window length and does not have fixed time – frequency resolution [2].

Mathematically, the continuous wavelet transform is calculated as by summing over all time of  $f(t)$  convolved and shifted versions of the analyzing wavelet function  $\psi$ :

$$C(\text{scale}, \text{translation}) = \int_{-\infty}^{+\infty} f(t)\psi(\text{scale}, \text{translation}, t)dt$$

$$C(\sigma, \tau) = \int_{-\infty}^{+\infty} \frac{1}{\sqrt{\sigma}} \psi\left(t - \frac{\tau}{\sigma}\right) f(t)dt$$

Where the term  $\frac{1}{\sqrt{\sigma}} \psi\left(t - \frac{\tau}{\sigma}\right)$  is an envelope of the scaled and the shifted wavelets and  $\sigma, \tau$  are scale and shift parameters, respectively [2]

For establishing the relationship between frequency and the layer thicknesses, we have made a cross plot of frequencies and the sand bodies thicknesses. From this

cross plot, we have analyzed the spectral decomposition response of bright amplitude responses of various sand bodies. We selected sand bodies of various thicknesses such as 12m, 14m, 18m, 19m, 26m, and 30m from the surrounding wells. These sand thicknesses were plotted against the various CWT-frequencies.

In addition to spectral decomposition we have also calculated the average attribute and reflection strength attribute. Average energy is defined as the square of RMS amplitude. There are two main applications of average energy; depicting the depositional environments, sharp interfaces of lithological contrast. Thus, it is important to incorporate for inferring the depositional environments.

Reflection strength has wide application for reservoir characterizations. It is defined as the Envelope amplitude or reflection strength is defined as the root square of square seismic trace plus square quadrature trace. Highest value of envelope amplitude infer as major changes in the lithology such as unconformities or presence of gas [9].

Mathematically, it is defined as

$$E(t) = \sqrt{[f^2(t) + g^2(t)]}$$

$t$  varies approximately between 0 and the maximum amplitude of the trace. The envelope relates directly to the acoustic impedance contrasts. And therefore, can be used as hydrocarbon indicator. This attribute was incorporated for inferring the channel fill lithology. First, we have generated the horizon slice at the shallow reservoir level, and proceeded at the deeper reservoir level to have a clue for the deeper reservoir level. For this purpose, we have generated some time slice of amplitude at two shallow levels (Fig. 4).

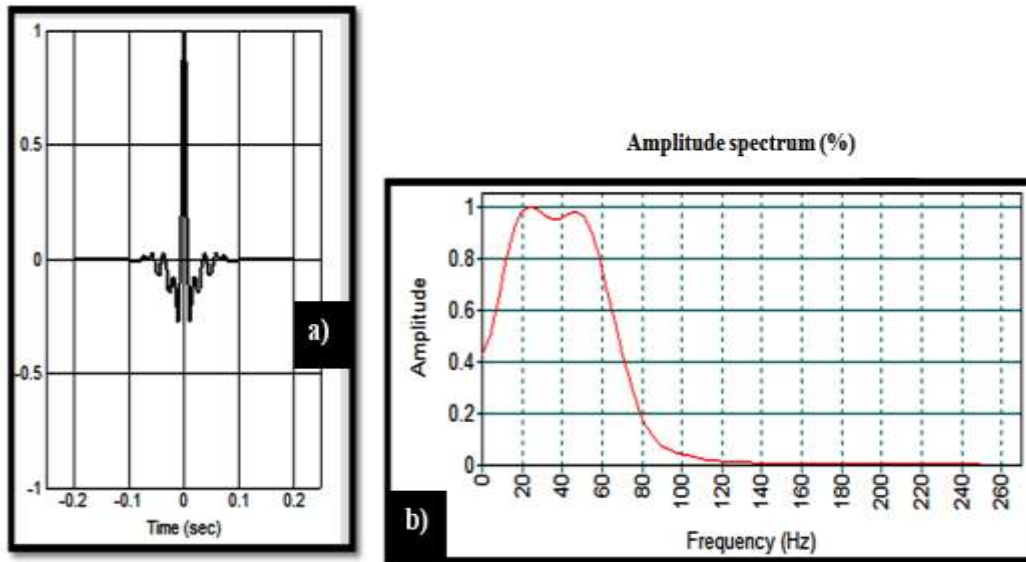

Figure-4: Computed Amplitude Spectrum at the reservoir level. a. Extracted Wavelet b. Frequency Spectra.

## 4. RESULTS AND DISCUSSIONS

### 4.1 Synthetic Seismogram

The seismic data is of normal polarity with an increase in acoustic impedance being represented by a peak. The Synthetic seismogram of one well is used for the reflector marking (Fig. 3).

### 4.2 Spectral decomposition Model of sand bed thicknesses

According to the cross plots of sand bodies and frequency (Fig.5), as the frequencies increases we are getting the thin sand beds. From the frequency – thickness relationship, it may be infer that which frequency will be suitable for exploring the specific sand body of various thicknesses. As an example, one can infer that to explore the thin bed of less than 10 m thick sands, it would be better to analyze the 80 Hz frequency slice for lateral distribution of this sand bed. Similarly, to explore the sand bed of 30 m thickness, it's better to analyze the 15 Hz frequency band of CWT-SD. It is also clear that, the amplitude spectrum of these sand bodies drops drastically between 30 Hz and 50 Hz. However, we may infer that bright amplitude at frequencies between 30Hz and 40 Hz may show the thick sand between 15m and 25m

According to the spectrally decomposed output cubes at the representative wells, robust results for sand layer thicknesses are observed, and are depicting the significantly excellent response of spectral decomposition from different sand bodies' thicknesses. At the same sand bed thicknesses in a well, low frequencies are showing the thick sand beds (Fig. 6a, and b), while the higher frequency components of amplitudes brighten, above the 1550 ms (Fig. 6c, and d), thin beds are encountering in the high frequency volumes, while the thick beds of sands are encountering in the low frequency components [10]

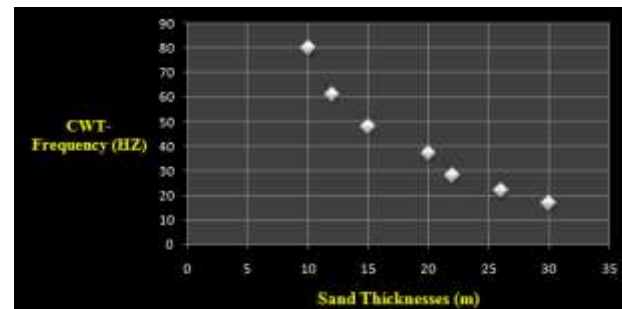

Figure-5: Cross Plot between Sand Thicknesses and Frequency Maximum Amplitude Response

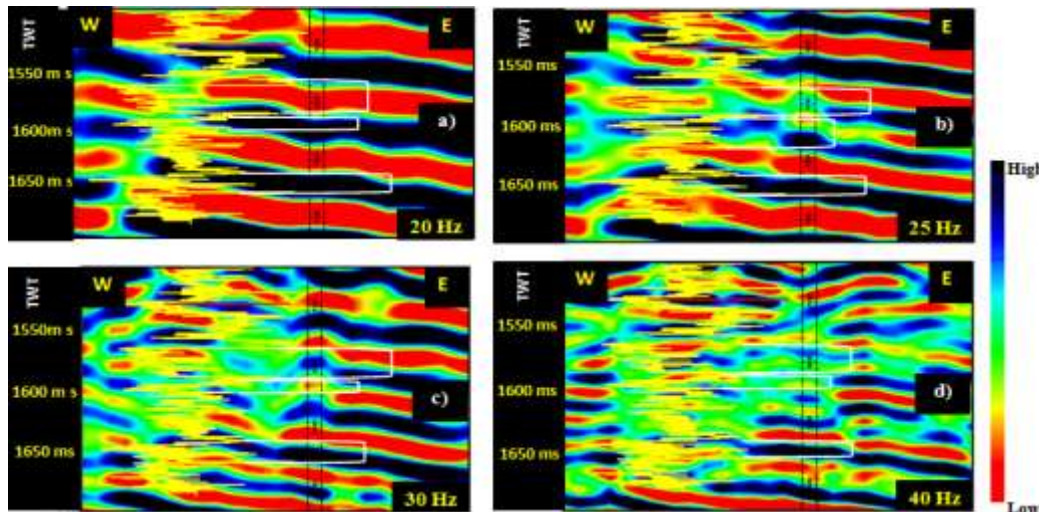

Figure-6: Spectrally decomposed CWT isofrequency volumes along the representative well section a.20 Hz, b.25 Hz, c.30 Hz, and d.40Hz.Thick sand beds demonstrate bright amplitudes at low frequencies (a and b), while the thin sand beds demonstrate bright amplitudes at higher frequency (c and d). Yellow curve is the gamma ray curve (increases towards right) while the white flags are the gas pay zones encountered in the reservoir zone of interest.

## 5. SEISMIC GEOMORPHOLOGY AND HORIZON ATTRIBUTES ANALYSIS

Multiple horizon slices such as Lower Goru, C-Interval, Sand 1 and Sand 2, were thus selected in the zone of interest to understand the lateral and vertical variations in sand distribution patterns occurring in the channels geometries by observing different seismic attributes. Our

main emphasis remained on CWT –SD 22 Hz horizon slices.

This is the shallowest slice of seismic amplitude attributes (Fig.7). As, the seismic amplitude provides detailed stratigraphic and reservoir characteristics [11]. This horizon slice clearly demonstrates the point bars indicated



by red arrow at the SW margins. Length of this meander belt is about 7 km with sinuosity index of 1.9.

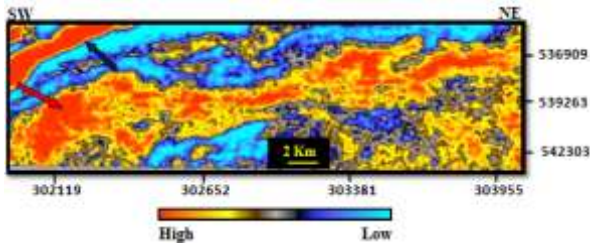

Fig 7: Amplitude Time Slice at 1212 m.sec.

### 5.1 Analyses of CWT-SD Sand Horizon Slice

This is the horizon below C-Interval. We may see that the 22 Hz iso frequency volumes and average energy (Fig 8a, b) indicate low sinuosity features as compare to the seismic amplitude slice (Fig.8). Due to limitations; average energy is not presenting the best image for

crevasse splay like feature indicated by red arrow at the southwestern flanks (Fig 8a.) However, CWT-SD 22 Hz, have excellently imaged these hydrocarbon bearing features. Southern most margins there are some high amplitude (Fig. 8a). These high energy zones are showing the massive sand lithologies, which are also confirmed from the nearby producing wells. Hence, these zones can be interpreted as high energy environments (Fig. 8a). On the other hand, CWT-SD 22 Hz (Fig. 8b), the broad amplitudes are now becoming narrow on the northeastern margins indicated by blue arrow. Northwest –southeast trending regional faults are also shown by the blue lines on both the slices (Figs. 8a, b). These faults most probably be created by the channel. On the south western regions on both the slice (Fig. 8a, b), the crevasse like features indicated by the red arrow on (Fig. 8a), and by large blue arrow (Fig. 8b) where there is massive sand presence is obvious. Paleo-flow of water was northwestern to south eastern directions.

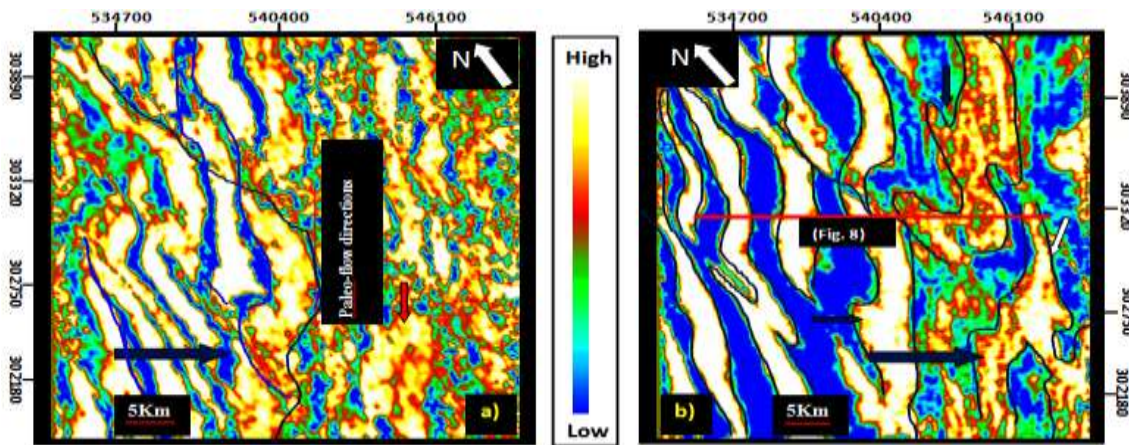

Figure-8. Horizon Slices at Time 1644 msec. a. Average Energy b. Spectral Decomposition 22 Hz.

Now, as the deeper reservoir level encounters (Fig. 9), the bright amplitudes broad point bars are encountering. There are the amplitude attenuations at the reservoir level of interest. This amplitude attenuation may be attributed to the gas presence in point bars geometries. According to literature, the depositional environment of reservoir strait is fluvial-deltaic. (Fig. 9), the central part is showing the meander feature surrounded by the wells, and extending from southern to northern margins. The length of this meander belt is 3.5 km. On the north-eastern flank, that there is a massive sand body present. This sand body is 1.5 km wide. So, north-eastern most margins are showing positive signs for the presence of hydrocarbon prone sand in the form of bright amplitudes of point bars. So, the eastern flanks of the survey may be more promising than the western flanks for hydrocarbon perspectives. There is a good well control and these bright low amplitudes of CWT-SD are also confirmed from the nearby surrounding wells (Fig.10). Gas pay zones are encountered at various levels. Although the broad sand geometries are

surrounded by the wells-05, well-06, and well-07. But, the well-05 (Fig. 10) is depicting more positive signs for the hydrocarbon presence. Well-05 may be more productive in the future as, gas pay zones are encountering at both the shallow and the deeper reservoir level. These pay zones are lying in the reservoir level, which also validates our results regarding the hydrocarbon presence.

A comparison between the CWT-SD 30 Hz and 40 Hz slice is shown (Fig.10). It is obvious that, again the eastern flanks of the survey are showing a little narrow meander belt (40 Hz) right as compared to the (30 Hz) left slice. From the cross plots for frequency and the layer thicknesses (Fig.5), these observations are now validated from these two slices of (30 Hz) left and (40 Hz) right CWT-SD slices. As the higher frequency component come across more thin beds are attain and vice versa. Similarly, these possible hydrocarbon prone geometries are also confirmed from the nearby wells. (Fig.11)



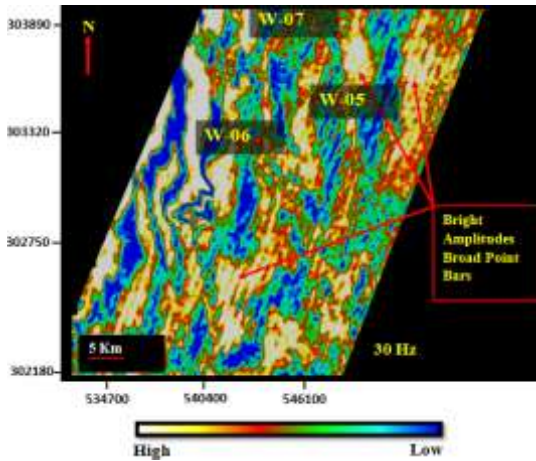

Figure-9: 30 Hz Amplitude Slice at 1655 ms of the Reservoir Level.

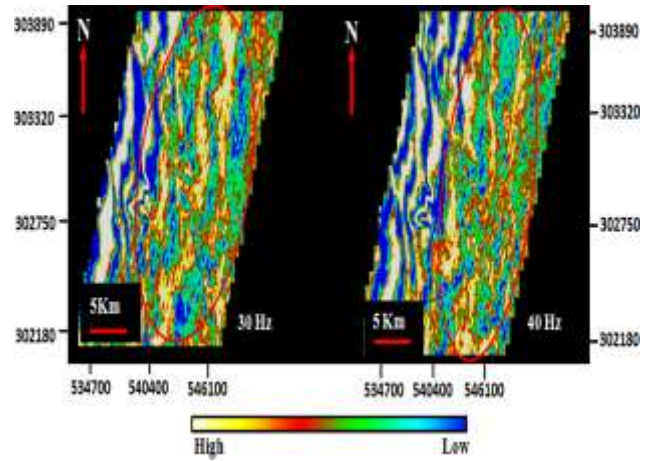

Figure-10: 30 Hz and 40 Hz Amplitude Slices at Deeper Reservoir Level of 1677ms.

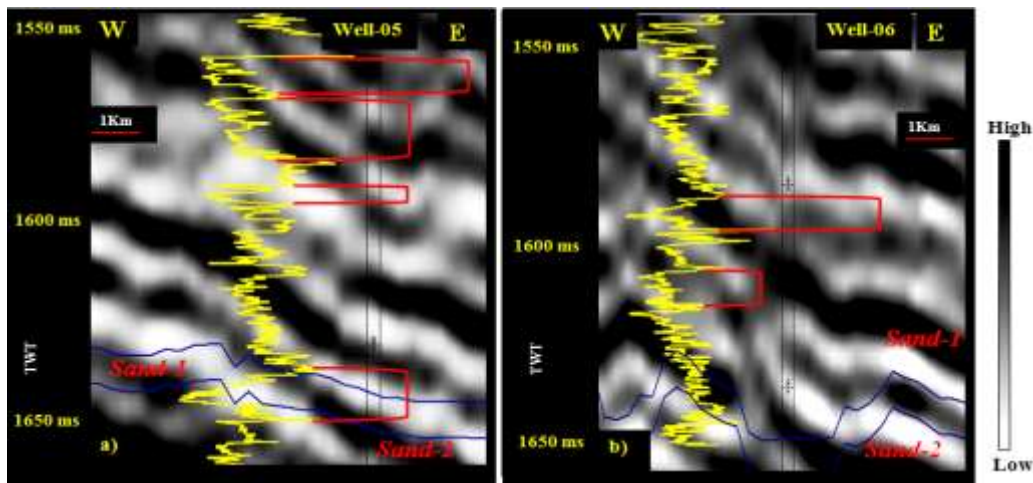

Figure-11: Amplitude seismic sections along the representative wells. a. well-05, b. Well-06. Red blocks are representing the gas pay zones. Well-05 is showing the gas pay zones at both the shallow and deeper reservoir level, but, Well-06 represents gas pay zones at the middle reservoir level.

## 5.2 Lithological Analysis

Up to this stage phase of the research, the lateral sand distribution was analyzed. For accessing this accuracy, we have utilized the vertical seismic sections of instantaneous amplitude (reflection strength) and the seismic amplitudes (Fig. 12a, b). The fluvial-deltaic heterogeneous environments have created the difficulty for exactly matching the channel filled lithology so, to identify the exact lithology of the reservoir formation, reflection strength was the best choice for this purpose. And it is incorporated for identifying the hydrocarbon prone sand infill lithologies.

Lithology identification within the channel fills can be inferred from the instantaneous amplitude (reflection strength) which has various applications, but this attribute is incorporated as a hydrocarbon indicator by inferring

lithologies of the channels fills (Fig. 12b). High values are revealed by yellow colour depicting the high energy, porous sand filled channels (Fig. 12b), while the black colour is providing a match for convex downward amplitude channels (Fig. 12a). As, the massive point bars and the crevasse like stratigraphic depositional features are of hydrocarbon interest, hence this attribute can be used for detection of the sand filled channel lithologies that are showing different acoustic impedance contrasts [12].

Coarse sand filled channels are the reflections of high energy environments and the intermixed mud filled lithologies are the reflections of low energy environments. These depositional features may be seen on the displayed vertical seismic inline 2960 section (Fig. 12), where there is strong reflection amplitude (Fig. 12a) and the high amplitude high energy environment is

confirmed from the vertical section of average energy attribute (Fig. 11a).(Fig.13) depicting the of the sand filled channels. The channel fill lithology is diligently

confirmed from the vertical section along a representative well.

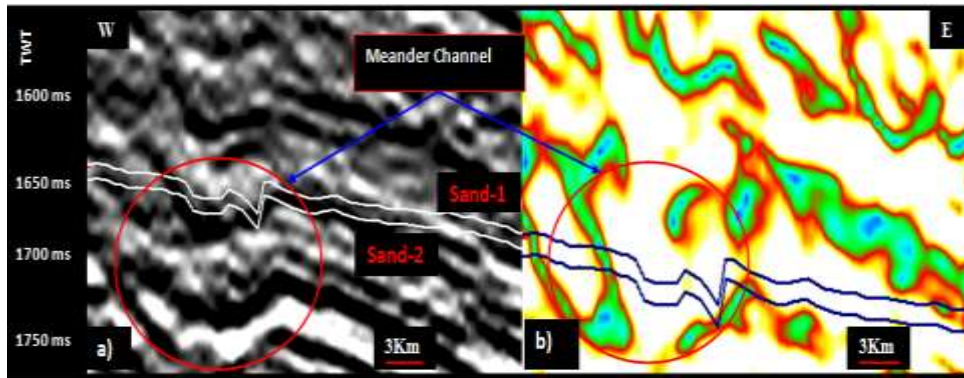

Figure-12. a. Seismic Inline 2960 Passing the Meandering Channel. b. Reflection Strength Attribute Applied to the Same Section.

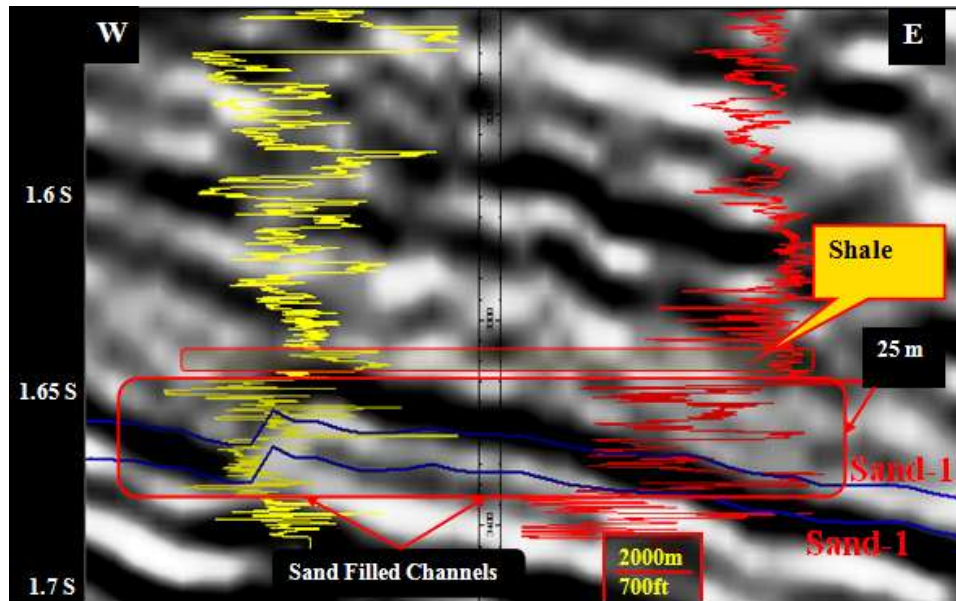

Figure-13: Amplitude section along the representative well. Lower black bar represents the gas sands pay zones, while the upper small block showing the shale interval at the reservoir level. Red curve is the density log, while yellow curve is representing the gamma ray log (both increasing towards right).

In summary, the bright amplitudes broad point bars, and crevasse like depositional features may be more favorable for hydrocarbon exploration on eastern flanks as compared to the high amplitudes narrow channel like features on the northwestern flanks of the horizon slices (Figs. 7, 8, 9,10).

## 6. CONCLUSIONS

Investigations have been carried on the Miano Gas Field in perspectives of lithology and possible hydrocarbon prone thin sand reservoir recognizing by the approaches of continuous wavelet transform technique of spectral

decomposition and conventional seismic attributes such as average energy, reflection strength to a 3D post stack seismic data. Since, massive sand facies such as point bars, crevasse like depositional features are of great importance in context of hydrocarbon exploration. At the Lower Goru level, average energy could only give clue for these depositional features due to bandwidth limitation.

However, CWT-SD has proved and the continuous wavelet transform technique of spectral decomposition has remarkably delineated the channel geometries and the thin gas sand beds associated with these depositional

features. Therefore, CWT-SD along with some conventional attributes can be used to identify the remaining hydrocarbon prone features by planning of wells of Miano Gas Field, Lower Indus Basin of Pakistan.

## ACKNOWLEDGEMENTS

We are thankful to Directorate General of Petroleum Concession for giving the permission to publish this paper. We are also thankful to Department of Earth Sciences, Quaid-i-Azam University and LMKR for providing the research data.

## REFERENCES

- [1] Castagna, J.P. 2006. Comparison of spectral decomposition methods. *First Break*, 24:75–79
- [2] Sinha, S., Routh, P.S., Anno, P.D., and Castagna, J.P. 2005. Spectral decomposition of seismic data with continuous-wavelet transform. *Geophysics*, 70:19–25.
- [3] Berger, A., Gier, S., and Krois, P. 2009. Porosity-preserving chlorite cements in shallow-marine volcano clastic sandstones: Evidence from Cretaceous sandstones of the Sawan gas field. *Pakistan American Association of Petroleum Geoscientists, Bulletin*, 93:595–615.
- [4] Kadri, I. B. 1995. *Petroleum geology of Pakistan*, Graphic Publishers, Karachi. pp. 93–108.
- [5] Shah, S. M. I. 1977. *Stratigraphy of Pakistan*, 12, Geological Survey of Pakistan. pp.43–51.
- [6] Krois, P., Mahmood, T., and Milan, G. 1998. Miano field, Pakistan, a case history of model driven exploration: Proceedings of the Pakistan Petroleum Convention. *Pakistan Association of Petroleum Geologists, Islamabad*, 111– 131.
- [7] Ahmed, N., Fink, P., Sturrock, S., Mahmood, T., and Ibrahim, M. 2004. Sequence stratigraphy as predictive tool in Lower Goru Fairway, Lower and Middle Indus Platform, Pakistan. *Pakistan Association of Petroleum Geoscientists, Annual Technical Conference*.
- [8] Partyka, G., Gridley, J., Lopez.1999. Interpretational applications of spectral decomposition in reservoir characterization. *The Leading Edge*, 18: 353-360.
- [9] Taner, M.T., Koehler, F., and Sheriff, R.E. 1979. Complex seismic trace analysis: *Geophysics*, 44: 1041-1063.
- [10] Mirza, N. A., Rowell, P., and Sriburee, S.2014. Detection of fluvial sand systems using seismic attributes and continuous wavelet transform spectral decomposition: case study from the Gulf of Thailand. *Mar Geophys Res.* DOI 10.1007/s11001-014-9213-0.
- [11] Brown, A. R. 2004, chapter 9, *Interpretation of Three-Dimensional Seismic Data*, AAPG Memoir 42, pp. 541, Contributed by Rebecca B. Latimer, Chevron U.S.A.
- [12] Walls, J.D., Taner, M.T., Taylor, G., Smith, M., Carr, M., Derzhi, N., Drummond, J., McGuire D, Bregar, S., and Lakings, J. 2002. *Seismic reservoir*

characterization of a US Midcontinent fluvial system using rock physics, post stack seismic attributes, and neural networks. *Lead Edge* 21:428–.

## AGILE MANUFACTURING IN SEASONAL DEMANDED SME'S

Tishawar Sharif\*, Muhammad Farooq\*, Hassan Farooq\*, Muhammad Tayyab\*

### ABSTRACT

Today's business environment is characterized by fast-changing technologies and shorter product life-cycles, well-educated customers and fierce competition. Within this context, agile manufacturing is praised in the literature as one of the solutions for achieving and maintaining a competitive advantage in turbulent times. This paper is aimed to fill in the identified theoretical and empirical gaps by exploring and scrutinizing the agile manufacturing concept in small and medium enterprises (SMEs) in the FAN manufacturing industry in Pakistan. Furthermore, a model illustrating the agile manufacturing enablers praised in literature and useful for studied industry is developed. A questionnaire has been developed based on the agile manufacturing enablers in the literature. Then a survey has been conducted on the developed questionnaire to find the application of praised agile manufacturing enablers in the industry and the extent of application. Result of the survey has shown that the agile manufacturing enablers are partially applied in the studied industries. Nevertheless, a conscious awareness of the agile manufacturing concept itself was not found and the enablers identified were rather described as logical business thinking.

**Keywords:** *Agile Manufacturing Parameters; Agile Business ; Factors Affecting on SMS's*

### 1. INTRODUCTION

Companies in the recent time have been challenged by the fast changing global business environment and the customers' demands. Due to this reason large scale companies have changed their production environment by implementing different world class techniques like JIT, TQM, Lean and agile manufacturing to improve the quality and productivity[1].The Small and Medium Enterprises (SME) have faced the same challenge. They are also competing for the favor of the customers.

The concept of agility and agile manufacturing (AM) is a new concept of operating business to achieve competitive advantage in turbulent business environment [2-4].[2] in particular investigates the relationship between agility, resilience and turbulence. The study shows that out of 471 North American companies, the ones investing in agility and resilience have significantly better performances and profitability during the time of intense turbulence. Therefore to continue, survive and grow, an SME needs to develop robust new products, which meet customer expectations in an agile manner.

### 2. LITERATURE/RESEARCH CONTENTS

Literature provides ways to structure AMEs (Agile

Manufacturing Enterprises). For example[5] identify seven key AMEs to respond quickly to changes of the environment which include (1) virtual enterprise formation tools; (2) physically distributed manufacturing architecture and teams; (3) rapid partnerships formation tools/metrics; (4) concurrent engineering; (5) integrated product/production/business information systems; (6) rapid prototyping; and (7) electronic commerce. However, this is not the only way of representing the enablers for AM[4] created a discussion of the different enablers. Furthermore, they also identify three resources to implement AM, namely: technology, management and workforce. This is coherent with[6], pointing out that all the manufacturing strategies need to be based on these resources, namely (1) innovative management structure and organization, (2) a skill base of knowledgeable and empowered people and flexible and (3) intelligent technologies. In addition, it is important to understand that AM has to be carried out at a companywide level[7, 8] (Christopher, 2000).

Scholars have been researching the different enablers of AM since 90s. As a consequence, there is an extensive list of AMEs that one can draw from all of these researches.

Technology is often expressed as being essential for the

---

Corresponding Author:

\* Engr. Hassan Farooq , Ph.D Research Scholar, Mechanical Department University of Engineering & Technology Taxila,Pakistan Email:engineerhassan.mech@gmail.co.

Co Authors:

\* Malik Tishawar, Engr. Muhammad Farooq, Engr. Muhammad Tayyab PhD Research Scholar, University of Engineering & Technology Taxila,Pakistan

implementation of AM[9]. A variety of technological options have been identified as AMEs. For example, some authors argue that AM should contain automation[10, 11] while some opt for manufacturing cells [4, 12]. However, most of the authors agree on the fact that IT(Integrated Technologies) systems are crucial for AM[7, 9, 10, 13-15][12, 16][4, 13]. But once again, the type of IT systems can vary between the most elaborated Enterprise Resource Planning (ERP) systems to a simple email box[17, 18].

The management resources also play a very important role in achieving AM. [12, 19].For instance, an important criterion in reaching AM is a collaborative relationship with the customers and the suppliers in order to better sense the changes in the environment and also to create a better match in the supply chain[7, 20, 21].This network cooperation is essential in the creation of the “extended organization” and can take place together with concurrent engineering[4, 13, 22, 23].

The workforce appears in the literature to be a crucial resource for AM. First, in order to fully exploit the technology resources in the organization, AM needs an educated workforce see for example[24]. Furthermore, the employees’ ability of multifunctional working can increase the company’s agility[4, 25, 26],which as a consequence can reduce the dependence on key employees. This can be facilitated by an access to continuous learning and training[11, 25], and the creation of a learning organization by the management (Yusuf, et al., 1999). The empowerment of employees given by a higher autonomy and high decentralization is identified as another important input for AM[11, 26-28]. The objective therefore, is to train the workforce to become a flexible resource by itself. In turn this enables the employees to not only acquire cross functional knowledge but also to be more enthusiastic about their work, which as a result can lead to a reduced absenteeism[16, 26].

Availability of knowledge data base is essential for AM[12]. Academic literature related to the activities involved in the manufacturing and their availability to the concerned staff is an important factor for achieving Agility in manufacturing system[29].

Design of product being manufactured should be based on the strategy which correlates the goals of AM. Like it should be customizable, upgradable, it should be being designed after getting a feedback from end users [16, 30, 31].

Supply chain is very important element in achieving agility in manufacturing, a supply chain which is market sensitive, having high level of interconnectivity among the members with transparent information sharing among them is transparent is essential for that[7].

Lean manufacturing is important strategy for agile manufacturing[32]. Lean supply is closely associated with enabling flow and the elimination of wasteful variation within the supply chain[33, 34]. JIT-purchasing has a direct positive relationship with agile manufacturing while the positive relationship between JIT production and agile manufacturing is mediated by JIT-purchasing[24].

The AMEs are separated in the work force knowledge management information technology product design supply chain manufacturing strategy, even though these are deeply connected, making it sometimes difficult to distinguish. Within this context, table is an attempt to create a coherent framework of AMEs from a variety of different taxonomies used by different scholars. Following is a Table:1 comprising on agile manufacturing Enablers identified in literature.



		Breu et al. (2002)	Brown & Bessant (2003)	Christopher (2000)	Corbett and Cambell (2002)	Coronado(2003)	Goldman et al. (1995)	Gumasekaran(2001)	Ismail & Shariff(2006)	Jiang(2007)	Kumar et al.(2005)	Lin et al.(2009)	Power &sohal(2001)	Ramesh &Devedasan(2005)	Ribeiro(2010)	Sharif& Zhang(2001)	Sherely et al. (2007)	Yusuf et al. (1999)	christopher et al.(2004)	Sexana(2000)	Gumasekran (1999)	Anthony et al. (2007)	Debra A et al. (2004)	HeshmaulMasood(2007)	Yi Hong et al (2011)	K. Jeyakumar et al. (2012)	Shad et al. (2005)	VeranaDischler et al. (2011)	S. Vinodh et al. 2013	Chang Wu et al. (2010)	Song Ming et al. (2007)	Martin Christopher (2000)		
Work Force	Is there Decentralized decision making ?	<	<				<	<						<	<	<		<					<	<	<									
	Is Continues education and training conducted?										<			<	<				<				<		<									
	Is there Team work?													<	<				<				<					<						
	What is level of Multifunctional workforce?			<	<			<			<			<	<	<			<			<			<									
	Is there Committed work force?		<													<			<				<					<						
	Are there knowledgeable workers with I.T?			<				<											<			<		<										
	Is there Quick decision Process?											<							<					<										
Is there Good internal relations between departments and employs?							<	<						<	<		<					<				<								
KndgeInngnt	Is there Availability of Database?								<				<						<			<	<			<		<						
	Is there Academic literature?					<									<				<				<			<		<						
	Is there Transparency of information?	<	<					<	<			<	<					<																
	Is there Mechanism to disseminate the best practices?			<		<										<				<			<	<			<							
I.T	Is there Internet based communication?			<				<	<	<	<		<	<	<	<			<		<		<			<	<							
	What is level of MRP?			<				<		<	<		<	<	<				<		<		<				<							
	Is ERP implemented?			<				<	<	<	<		<	<	<				<		<		<				<							
	Is there CRP?			<				<	<	<	<		<	<	<				<		<		<				<							
	Level of CAD?			<				<	<	<	<		<	<	<				<		<		<				<							
	Is there Database concept?			<											<							<		<			<							
	Is there Customers feedback for product design?					<	<	<		<			<				<					<		<		<								
Product Design	Is there Upgradeable design?													<					<		<		<		<									
	Is there Design modularity?													<					<		<	<	<		<									
	What is customers integration with design process?						<		<				<														<							
	Is there Customizable design?													<					<		<	<	<		<									
	Is there Process interconnectivity between network members?	<	<	<			<	<	<	<	<	<	<		<		<	<	<	<		<		<		<		<	<	<	<	<	<	<
Supply Chain	How Flexibility by using the strengths of specialist players ?			<															<		<		<											
	Is there Supply chain is market sensitive?			<															<		<		<				<							
	What is mode of Information sharing among all chain partners?			<			<	<				<							<		<	<		<				<	<	<	<	<	<	<
Manufacturing Strategy	Is there Lean manufacturing?						<		<					<										<										
	Is there Automation?						<		<			<				<			<					<			<							
	Is JIT Implemented?	<	<	<																	<	<				<		<						
	Is TQM implemented?	<	<				<		<	<									<				<				<							
	What is level of Flexible manufacturing system?													<	<		<		<									<						
	Is there Mass customization?	<	<																			<		<		<								
	What is level of Concurrent engineering?							<		<					<	<	<	<								<								
	Is there Manufacturing cells?						<					<											<		<									
	Is there specialization on core products?							<					<		<	<							<				<							
	Is there Modular reconfigurable system?						<		<		<			<			<				<					<								

### 3. INTEGRATION

The resources and enablers for agility cannot be understood alone. It is stated in the literature [6, 17] that integration is the key to a successful implementation of AMEs.

### 4. AGILE MANUFACTURING IN SMES

While the literature is rich with regard to AMEs for large companies, it is noteworthy that the applicability of these AM practices for SMEs has been largely neglected. This shortage is surprising as SMEs are an important factor for the economy of any country [35, 36]. The purpose of this research paper is to fill this gap by investigating SMEs. In coherence with this aim, a short literature review will provide an overview of what has been done within the field of AM in SMEs.

By highlighting that AM can be defined as relying more on people and their creativity than on the process itself, [13, 37] illustrate the agile methods used by SMEs in the construction area. The authors emphasize that the interviewed managers recognize the main AMEs in their people, the collaboration of business partners, organizational culture and technology [13] and the benefits of implementing AM. However [13] also highlight that the application of AMEs requires a strategic shift which can lead to hurdles with regard to the implementation. Within this context, [10] emphasize that in the quest for competitiveness, a crucial factor is the capability of SMEs to respond to the turbulent market by implementing appropriate manufacturing procedures and by finding a niche for their business.

Another research has been conducted with regard to the effectiveness of IT within SMEs, giving guidelines on how SMEs can manage agility. The results emphasize the need to develop people's skills and expertise in IT to reach agility [9, 38].

A further research carried out by [39] highlights a gap between the application of the LM (Lean Manufacturing) and AM concepts with regard to SMEs and large companies. While in large companies, LM is a step towards becoming agile, SMEs are capable of avoiding many elements of LM [39, 40] goes even further, stating that SMEs should neglect the lean concept and concentrate solely on achieving and maintaining AM by using enabling tools, like workplace organization and quick set-ups. This view, however, is a contradiction to the statement of other authors who describe LM and AM as not mutually exclusive [6, 7, 12].

However, most of the concepts and theories focus on large manufacturing companies they have not involved research or recommendations for small and medium industries. [41] has discussed agile manufacturing in aerospace industry. [5, 23, 39, 41-43] and thus highlight the lack of research in the particular field of AM in

SMEs. This scarcity of AM theory for SMEs is unexpected due to the fact that 99% of the companies in Europe are SMEs. With approximately 23 million companies and 75 million employees [35] SMEs are often named the "engine of the European economy" [35]. However, some studies could be found within the context of AM in SMEs. Implementation of MC starts with the design of product families that offer customers choice while optimizing the use of components. With a lack of understanding of how this is carried out, SMEs often embark on a strategy of offering customers more choice without a considered attention to the impact of this on their operations. It is often difficult for SMEs, with conflicting measures of performance and a proliferation of tools and techniques, to clearly identify how to proceed. The large enterprises can afford the risk of mistakes but small and medium can't afford this risk and are typically vulnerable, author recommends the design of products families that maximize the reuse of components [44]. A company's business environment, organizational culture, people management, collaboration and cooperation, flexibility, adaptability and technology are the most important factors for influencing the success of AMs in SMEs [13]. Studies on agile manufacturing in construction business for small and medium enterprise and concluded the key points required to shift toward agility are to find what are the key enablers and barriers for adopting agile methods, simple and flexible structure of organization, aligning the goals with agile values, promoting the new ideas discussions, multidisciplinary skills training and alliance with partners. Nevertheless, it is noticeable that the authors researching within this field highlight the challenges for SMEs in achieving and implementing AM. The spectrum thereby ranges from the required size of investment and lack of sufficient resources [42, 44] over the lack of bargaining power [44] to the need of changes with regard to processes and layout, as well as investments within the area of employee training and development [45]. While the mentioned challenges for SMEs obviously attract the researchers' interest, just a few of them concern themselves with how these developed strategies, concepts and theories can be applied in SMEs. A contradiction seems to appear when it comes to applying AM in SMEs. It is possible to assume that small and medium organizations would have strong capacities to become agile due to their flat hierarchy and thus a faster information and decision process. It can be reasonably imagined that compared to large organizations, SMEs have closer ties with their team members, as well as their suppliers and customers. Therefore, they should be able to sense and react in a more efficient and structural manner. However, as mentioned before, the literature highlights AMEs that seem out of reach for SMEs, due to their weak financial power [13].

It is concluded from literature review that the agile manufacturing has been used previously in large industries but there are very few clues of its implementation in small and medium industries and if there is then too in very small measures. Now in recent days in the view of rapid changing demands of customers it has become essential for SMEs to change their manufacturing model on agile manners.

## 5. METHODOLOGY

A methodology has been developed with the aim of achieving a data collection which will provide a way to compare the collected data with the AME identified in the literature and the extent of their applications. The object of this section is to provide the reader with an overview of the used research approach and strategy.

The design used in this study is survey. The target population for a survey is the entire set of units for which the survey data are to be used to make inferences. The target population for this survey is the production managers of the SMEs mainly.

production is also carried out in Lahore and Karachi. This industry primarily belongs to small and medium enterprisers (SMEs).

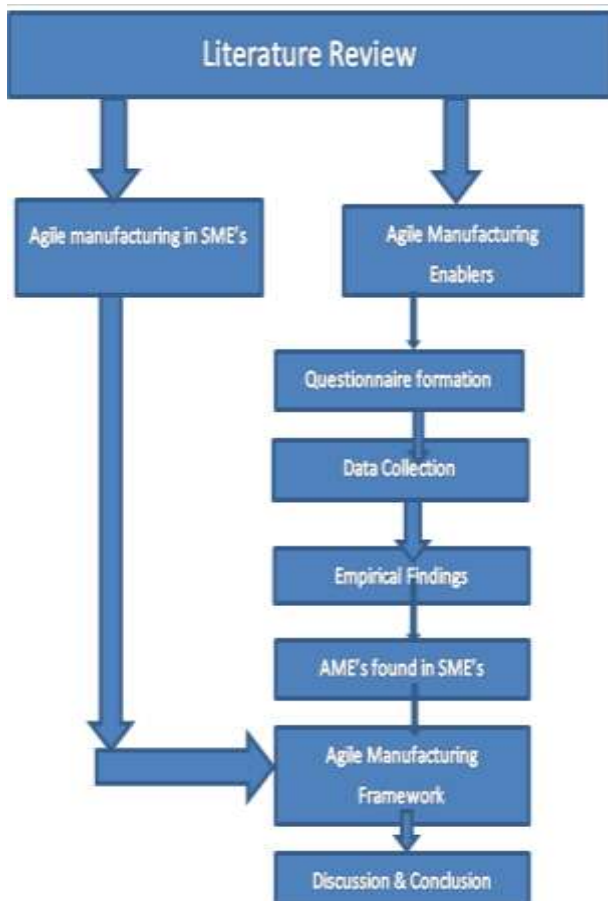

## 6. FAN INDUSTRIES IN PAKISTAN

Targeted industry for the study is FAN industry in Pakistan. Pakistan is known as the homeland of FAN industries in the region, it exports fans in a huge numbers to the region. Gujarat, and Gujranwala, are two key players in the production of fans which is almost 98%. Some of the There are 450 SMEs engaged in the production of fans both for domestic market and export. Out of this a major number of 300 units are known to exist in Gujarat. Fan sector is not only earning precious foreign exchange for the country but is contributing in multiple ways to the National economy. This industry employs up to 30,000 workers. However, the down side is that the production is mostly seasonal and confined to 1st six months of the year. Therefore the workers are not adequately skilled as they are forced to find alternative sources for earning livelihood. Few major companies have endeavored to keep their workers engaged throughout the year by shifting to related engineering products. A major contribution of the fan industry is that it has developed clusters in Gujarat and Gujranwala. Around 90% productions cater to domestic demands. It is interesting to note that local consumer demands better quality and innovative designs as compared to export products which are of low margins. Most of the companies operate under locally created brands with only a few moving towards international branding. Fan industry is producing around 90,000 indirect employment opportunities. Thus its contribution to total manufacturing employment is up to 1.54%. Pakistan's exports are mainly concentrated in low-income markets, such as Africa, Bangladesh and some Middle East countries. The average export price of Fans made in Gujarat and Gujranwala is around \$23-25, which is much lower than some of the more sophisticated fans which sell for around US\$400-500. The retail price of Pakistani fans in its export markets on the other hand varies between US\$35-40.

## 7. DATA COLLECTION

A detailed literature review is conducted to understand and explore the agile manufacturing enablers. Different authors have proposed different enablers for achieving the goal of agile manufacturing. These agile manufacturing enablers have divided into six different categories. A detailed four point likert scale questionnaire is developed to collect the data from the targeted industries. Questions of the questionnaire are based on the factors identified in the literature review according to different authors. These agile manufacturing enablers are enlisted in the table 1.

**Table 2: Research data overview**

Population under study	Manufactures within the FANS industry
Population census	60 surveys
Geographical area	Pakistan
Data Collection method	Semi-structured and open-ended interviews Structured survey
Sample size	60 answered questionnaires
Valid response rate of surveys	100%
Time frame	Mid of March – Mid of April
Respondent profiles	CEOs/managing directors, production managers, development managers

These questionnaires are filled by production managers and CEO’s of the relevant industries. Personal visits have been made to get the questionnaires filled and distributed in local language for better understanding.

**8. EMPIRICAL FINDINGS**

The findings of the conducted surveys are presented here. In total 60 surveys were filled out. Within this context, the literature review of AMEs provided the foundation for the survey questions, and thus were a source of insight information. The figures shown in this findings part reflect the results of the survey answers. At this point it has to be mentioned that survey is to identify the AMEs in the SME which are praised in the literature and to find the extent of their application in the SMEs again,

Investigated companies based on the number of employees are distributed in the following order.

- 76% \_\_\_\_\_ 10 to 50
- 16% \_\_\_\_\_ 50 to 100
- 6% \_\_\_\_\_ >100
- 2% \_\_\_\_\_ <10

The respondents’ professions were mainly CEOs/managing directors, production managers.

**9. AGILITY ENABLERS IN THE FAN INDUSTRY**

**A. Work Force**

Following are the questions asked in survey under the category of work force. Every question was offered with four scale choice from never, rarely, often to always.

WF1. Decision making is not centralized, in charge of respective areas are independent to take decisions in their domains. 50% companies responded it as always and 50% as often, it shows that owners or CEO don’t effect the decisions of the work flour managers and they are free to choice what they want to use for the best production.

It is being emphasized throughout the world that the involvement of the employees in the decision-making process is a tool to integrate their human resources and thus to create an understanding of the business itself. This was assumed by the managers for having a huge impact on the motivation and commitment of the employees.

WF2. Continuous education and training is being given to employees about new techniques and technologies.

80% companies replied it never, only 20% rarely. Mostly workers learn from senior employees, there is no special education or training for the job. On asking that they responded that there is no need of any particular training because the changes in the work are so minor and they are doing it for years so there is no need of continues education and training.

Training and education is considered as an important ingredient for the agile work force, authors have stressed on continues training of the employees to upgrade their knowledge and skill level to perform e the tasks. World view about this has main focused in the advanced and updated education and training should be a main part of the company’s policy.

WF3. There is a spirit of team work and collaboration in work force

66.7% replied always and 33.35 often. Mostly workers remains in friendly environment with each other and the small size of the industry help to get it because they are all well acquainted with each other hence there is a good team work spirit.

Good level of cooperation enhances the responsiveness and then customer service level, motivation to work in teams is highly recommended because of its synergy effects, it is widely praised and implemented in the world for the sake of achieving agility in the manufacturing process.

WF4. Work force is trained to perform multifunctional tasks if needed

100% answered it yes. As the process of assembly and the production line is not so much complex and long so all most all of the workers can perform all the tasks of the whole process but we can’t deny the fact that if someone is working on the balancing of fans for years and other one on the winding of motors they can’t be as good if we switch them but if there is need to do they can perform each other’s tasks at least. High training and capability to

perform the multifunctional tasks is recommended feature for the agile human resource, it reduces the time of response and make the more people available to perform the task if someone assigned is missing from the spot.

WF5. The workforce is committed to perform the assigned task.

20%often, 80% replied always. Workers are committed with their tasks.

High level of commitment is very basic need of an agile work force, responsibilities are given them to make them committed with the assigned tasks, without good commitment no work force can be an agile one.

WF6. Workers are knowledgeable with computer and IT solutions

From the responses 46%never uses IT, 53% rarely.IT solutions are mostly not adopted in the fan manufacturing SME's so workers are not knowledgeable with it, but now some companies have started using at least mail service for communication and almost everyone has made a page of their product on Facebook.

World is getting more and more IT oriented, IT is making an impact on every aspect of life, in manufacturing arena application of IT is getting high and higher with the passage of time so to cop the modern day needs of manufacturing it is globally accepted that the work force should be knowledgeable with the prevailed IT solutions relevant to the used manufacturing process.

WF7. Every shop floor manager is free to take decisions at his responsible work. Furthermore, decisions are taken and implemented quickly without wasting time.

From the resonses76% replied it often, 23%always. Owners usually don't interfere in the decision until it becomes very critical.

Being responsive on time without any delay is main focus of agile manufacturing , taking decision on time and then implementing them without any delay is a key to the agile shift, companies working on the agile concept of manufacturing have developed a very quick decision making process.

WF8. There are good internal relations between employees & departments

53% of the responses were always, 46%often Because of the small size of the industry relations are mostly good between employees and the section.

Good relation between the persons doing tasks is first and the foremost requirement of agility in the performance. Figure 2 is presenting all the factors about work force in the form of graphs.

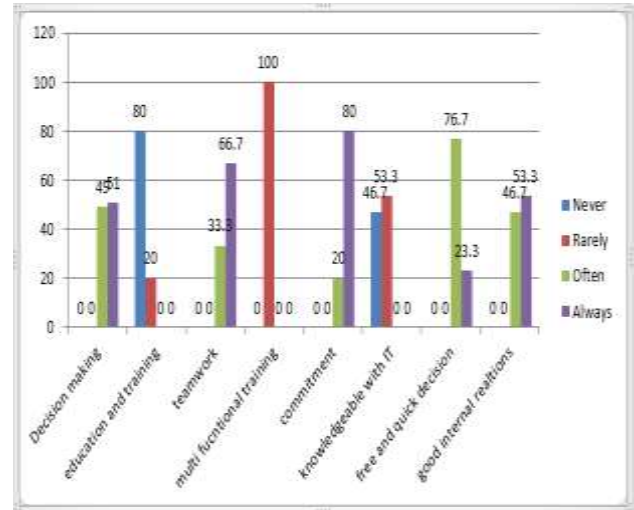

Figure-2 Work Force Factors

## B. Knowledge Management

Following are the questions asked in survey under the category of Knowledge management and their response. Every question was offered with four scale descriptions.

KM1. The company prepares his knowledge database which is accessible to all the workers

83% replied never and 16% rarely. There was no data base in the industries, sometime some manuals kept secure for the understanding of some new coming machine but as a specific data base there was nothing like that.

Availability of knowledge data base is one of the praised prerequisite of agile transformation, availability of relevant information regarding the manufacturing process, records of manufacturing activities etc. helps to expedite the manufacturing process, companies which are working on agile manners have developed their own knowledge data base.

KM2. Academic literature of work related activities is available

Academic literature regarding manufacturing activities and the facilities being used in the manufacturing process is recommended and being used widely in the world of agile manufacturing, it helps to train the new hired employees and to fix the problems if occur in the process of manufacturing.

From the responses 33%never use this facility 66%rarely academic literature in the form of specifications of different fans was available in some companies. But a special academic literature related to the activities was not present.



KM3. There is a Transparency of information (product and process related) flow in organization and partners which is not very much secret.

96% companies replied it to always, there is nothing like secret in the case of information follow everyone knows what is happening on the other corner or section of the industry and this is mainly because of the small size of the industry.

Transparency of information is very important and cardinal factor in achieving agility in the manufacturing process; it has a direct influence on the time consumption during the manufacturing process. Making the flow of information transparent can reduce the time utilized during the transferring the instructions and orders based on the hidden information, making it transparent and available to all reduce the extra layer of people hired for the conveying that information on the required time and consume time as well

KM4. The company has developed the best practice procedure, and proper mechanism is available to teach these practices to the workers.

100% replied it rarely companies are keep on manufacturing the products based on the already established ways, there is no research to find the best practice currently and then to teach it to workers.

With the passage of time and development of technology new and new tools and techniques have been developed by the researchers, so adopting them and then exploiting them for the best service of customers and gain of company is widely recommended as a key factor for achieving agility in manufacturing , it has been used worldwide with a considerable focus. Following figure 3 is graphical representation of the values of these factors.

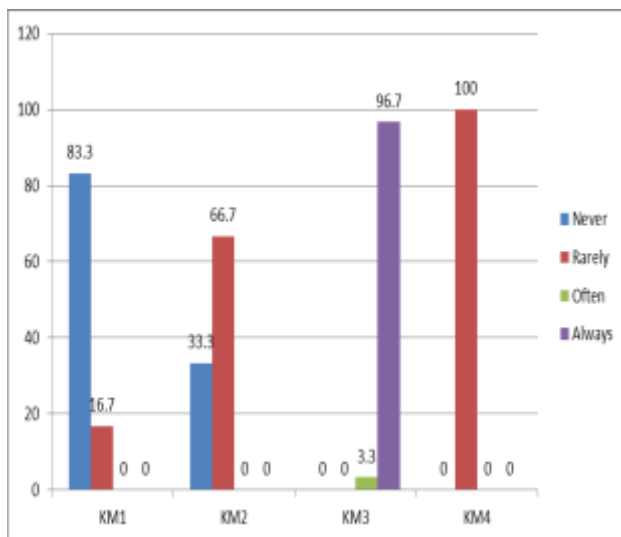

Figure-3 Knowledge management All Factors

### C. Information Technology

Following are the questions asked in survey under the category of Information and Technology solutions being used and their response. Every question was offered with four scale choice from never, rarely, often to always.

#### IT1. Internet based communication is used

53% replied never 46% rarely, few industries were using emails for their communication but most of the communication was from landline numbers and cell phones. So the scope of internet based communication was almost zero in the industries.

With the development of information technology the mods of communication have changed, now the communication has become faster than ever before , internet based communication is widely praised for the agile transformation of messages and coordination with partners customers and other related people.

#### IT2. Material Requirement planning (MRP)

As a common all industries use to plan their production material requirement for this production but as we are discussing material requirement planning under the umbrella of IT solutions so in this case there was not any software being used for this purpose across the board so the response was 100% never.

Information technology has developed the way to handle thing more easy and in more agile manners, application of software for the material requirement planning are being used worldwide in the industries for whom being agile is the motive of their production.

#### IT3. Enterprise resource planning (ERP)

Same is the case of enterprise resource planning as well, response was 96% never.

Software based enterprise resource planning is recommended by different authors and being used by different companies in the world for achieving agility in their manufacturing process.

#### IT4. Capacity requirement planning (CRP)

There was not any software being used for the purpose of capacity requirement planning, 100% responses were “never”.

Capacity requirement planning based on software is part of the solution for shifting conventional manufacturing system to the agile manufacturing system, largely praised and accepted all over the world as an agile enabler.

#### IT5. Computer added design (CAD)

There was no use of CAD software in the companies because generally they don’t need it and it they get need

to have a drawing of something they make it available from some designer but don't have this facility on their own. Response was 100% rarely.

Computer added design is one of the diversely used software for the design of parts of machines and other small parts of the products; it is among the recommended solutions for agile manufacturing and being implied as an enabler for achieving agility from conventional manufacturing system

IT6. Database (Product and process)

There was not any electronic data base, but emails saved for only those companies which use emails for their communication. 90% replied never to the existence of any data base in the industry.

Electronic data base is among the being used agile manufacturing enablers throughout the world; it reduces the time to make the desired information available to the respective people figure 4 is showing graphical details of IT related factors for agile manufacturing.

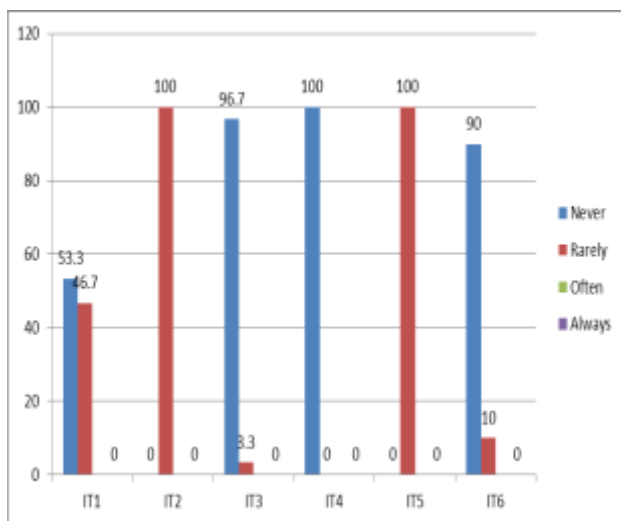

Figure-4 Information Technology All Factors

D. Product Design

Following are the questions asked in survey under the category of Product Design being used and their response. Every question was offered with four scale choice from never, rarely, often to always.

PD1. Company emphasizes that the Products are being designed after taking feedback from customers

73% replied to this question as never. There is no concept of taking feedback from customers to make a design of the product, however sometime some fan are prepared of special orders.

Design of a product is very important thing to keep under consideration, agile manufacturing not deal only with the

work Flore but with the customers as well, designing the product which has demand among the customers is a factors recommended and being used for achieving agility in manufacturing.

PD2. It is company's policy to Designs the products which are upgradable

From the responses 73% replied often 26% always. Fans are upgradable machine. You can change motor, wings buttons but these parts cannot be changed with some other size fan.

As the customers are becoming more and more sophisticated and particular in their demands, the design of manufactured products becoming more and more upgradable for being agile to respond the need of the customers. Throughout the world companies manufacturing on the agile manner are designing their products which are upgradable.

PD3. Company emphasize on the modular design of the products

From the responses 56% replied often 43% always. Design of the fan is mostly modular consisting on different parts.

Modular product designs are used in the companies working on the agile manufacturing grounds.

PD4. It is policy to integrated the customers in the process of product design

Customers are not the part of the process of product design, company himself decide what to design for the market, there isn't any such integration is present there. 96% responses were never.

It is recommended to take the customers in the process of product design, take opinion from them before designing the product to understand the nature of demand of the product you are going to manufacture, it is being used as an agility enabler across the world.

PD5. Company emphasize on the customized product design

80% replied there is not any customized product design but the different designs are available in the market and customers have to choose from them, while 20% responded that they sometime make customized products but it depends upon the order.

With person to person specific demand customized design products have become the need of the time, to respond this diverse nature of demand of the products companies are manufacturing customized products recommended by literature as an important agility enabler. Figure 5 represents the graphical details of product design related factors.

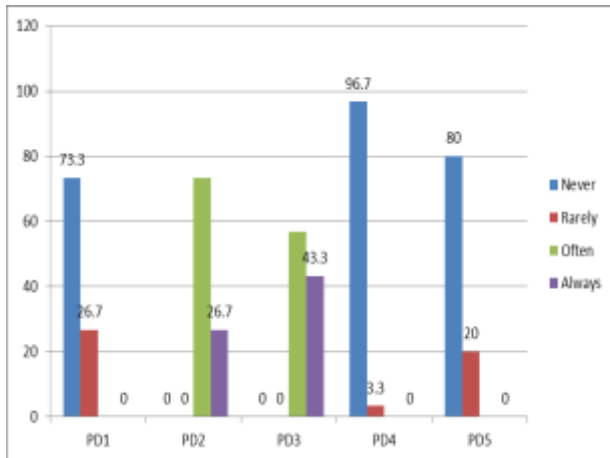

Figure-5 Product Design All Factors

### E. Supply Chain

Following are the questions asked in survey under the category of Supply Chain being used and their response. Every question was offered with four scale choice from never, rarely, often to always.

SC1. The company has a high degree of process interconnectivity With the suppliers

70% replied always there is a good interconnectivity in the supply chan. While comparing the supply chain enablers praised in literature with the SME's we have found that chains are very much agile, everything is available to the manufacturers in the market and there is no delaying as well. What all they need is to come up with money and take it.

An excellent interconnectivity with the partner suppliers is widely accepted as one of the important factor of agile supply chain, agile supply chains being used anywhere in the world are highly interconnected with the fellow suppliers

SC2. Supply chain gains flexibility by using the strengths of specialist Suppliers

73% replied it to always and 27 percent often, there are number of suppliers are available in the market who are very specialist and particular in their supplies.

Flexibility in supply chain is another recommended factor, flexible supply chains use the strength of the suppliers based on their specialists.

SC3. Supply chain is market sensitive in the sense of connection with the end users

Market sensitive means that the supply chain is capable of reading and responding to real demand. Most organizations are forecast-driven rather than demand-driven. Agile supply chains are used to be very sensitive to the markets to which they are responding.

Supply chain is very much market sensitive in the way that what products are being manufactured their supplies are always remained there in the market and there are no such huge changes in the products for which supply chain has to be sensitive for the change so for existing scenario supply chains are sensitive.

SC4. The company shares complete product information with its suppliers

There is no secrecy in the information follow, everyone knows everything about others. What they prefer to hid is their revenue and this is too from income tax officers not from suppliers. Figure 6 describes the SC factors in graphs.

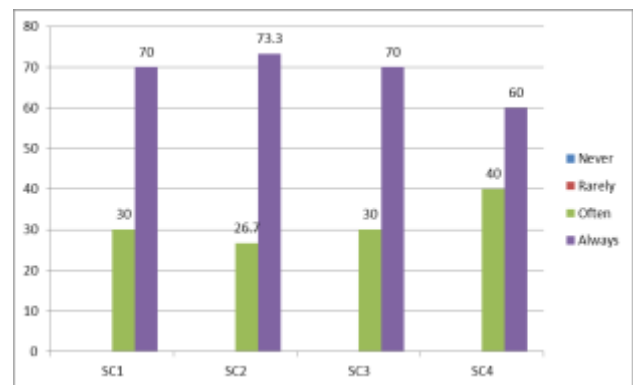

Figure-6 Supply Chain All Factors

### F. Manufacturing Strategies

Following are the questions asked in survey under the category of Manufacturing Strategy being used and their response. Every question was offered with four scale choice from never, rarely, often to always.

MS1. Lean manufacturing is applied for manufacturing

Respondents were not aware of what is the lean manufacturing actually but on describing they have told that they always remains in the pursuit to minimize the waste, hence 70% replied that the work on the principle of lean manufacturing in fan industries of Pakistan.

Lean manufacturing is one of the highly recommended and diversely used agile manufacturing enabler.

MS2. Automated manufacturing systems are in use for the manufacturing of products

There is no automation in targeted fan industry, most of the work is being performed manually, however some companies have acquired some automation like for winding of motors but no one is fully automated.

Automated manufacturing systems have become the order of the day; it has become impossible to cater the modern day manufacturing demands without them so they are

being used throughout the world for achieving agility in manufacturing.

MS3. Just in time(JIT) is implemented as manufacturing strategy

There is no concept of JIT in fan industry of Paksitan, 96% replied never. They keep on manufacturing fan on the orders and guess work in which they have become expert, they understand the market demands and the manufacture it on the bases of demands, when order is place the seek time for delivers, although some time if there are products in the inventory they deliver it immediately.

JIT is a globally recommended and used enabler of agile manufacturing; it has changed the manufacturing paradigm by eliminating the inventory.

MS4. Total quality management (TQM) is used in the company

Same is the case of TQM as was of lean manufacturing, 70% replied they keep on working to raise the quality of products, every time they do some sort of work they try to do it better than before but there was not any special accountability for TQM which is praised in literature.

Total quality management is an important and highly used agile manufacturing enabler, everywhere there is the motto of production is achieving agility TQM cannot be avoided,

MS5. Flexible manufacturing systems are in used for manufacturing

Depending upon the products being manufactured the available facilities are flexible, from the responses 73% replied it often and 26% always.

MS6. Mass customization is a focus of the company

There is not any concept of mass customization in SME's. 96% respondents replied it never. They produce things according to their design and then customers select from these available designs.

MS7. Concurrent engineering is a part of manufacturing process

Concurrent engineering is a part of process in the targeted industry; different sections keep on working to manufacture their related parts, and work concurrently with each other.

MS8. Manufacturing cells technology is applied for manufacturing

Manufacturing cell technology also has application in fan manufacturing SME's. Work floors are designed in the way that closely related machines are near about with

each other to help the process. Figure is about MS factors in graphs.

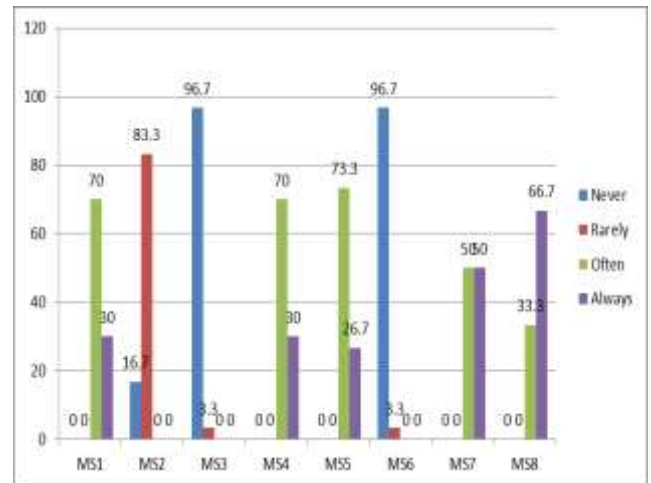

Figure-7 Manufacturing Strategy All Factors

As illustrated in the literature, it is crucial to reflect upon the ability of SMEs to integrate their different resources and therefore to create a coherent bundle of enablers. It appears that although the extended organization and the human resources of SMEs are highly integrated, these organizations lack a companywide initiative to develop a vision for AM. Therefore, the set of AMEs explained above is inherent to the organizations, rather than actively created for an overall agility purpose. Companies are lacking a consistent AM plan of action, which results in an incomplete consistency with the AM model praised in the literature. An overview of the existing AMEs in the organizations surveyed is provided using the table 3.

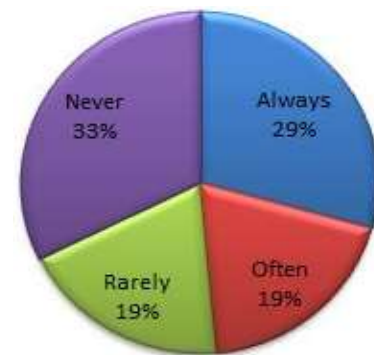

Figure-8 AME's distribution chart of Companies

#### G. Agile Manufacturing Frame Work

Keeping the findings of the survey under consideration and taking guidelines from literature about the AME's the following frame work (figure # 9) is prepared for the SME's in the fan industry of Pakistan. It can be argued that the main AME's are rooted in the workforce, knowledge management, information technology, supply chain, product design and manufacturing strategy. Some

of the AME's are being implemented up to some extent in the industries but not wholly especially in Pakistan. So the focus of the frame work is to keep all the praised AME's under consideration to recommend a way forward for their integrated implementation.

It can be concluded that the AMEs identified in the literature are partly reflected in the practices of the

studied SMEs. 29% AME,s always applied, while 19% often, 19% rarely and 32% never applied shown in figure 8, this comparison shows that SME,s are far away from implementing the praised AME,s. There is still a significant need to implement AMEs in SME,s in more progressive way to adopt the changing demands and then to react them timely.

**Table: 3 AME's Identified in SME's**

		Always	Often	Rarely	Never
Work Force	Decentralized decision making	✓			
	Continues education and training				✓
	Team work	✓			
	Multifunctional workforce			✓	
	Comitted work force	✓			
	knowledgeable workers with I.T			✓	
	Qick decision Process	✓			
	Good internal relationabt departments and employs	✓			
Knowledge Management	Availability of Database				✓
	Academic literature			✓	
	Transparency of information	✓			
	Mechanism to dissiminate the best practices			✓	
IT	Internet based communication			✓	
	MRP				✓
	ERP				✓
	CRP				✓
	CAD			✓	
	Database				✓
					✓
Product Design	Customers feedback for product design				✓
	Upgradeable design		✓		
	Design modularity		✓		
	customers integration with design process				✓
	Customizable design				✓
Supply Chain	Process interconnectivity between network members	✓			
	Flexibility by using the strengths of specialist players	✓			
	Supply chain is market sensitive	✓			
	Information sharing amnong all chain partners	✓			
Manufacturing Strategy	Lean manufacturing		✓		
	Automation			✓	
	JIT				✓
	TQM		✓		
	Flexible manufacturing system		✓		
	Mass customization				✓
	Concurrent engineering		✓		
	Manufacturing cells	✓			
	specialisation on core products				✓
	Modular reconfigurable system		✓		



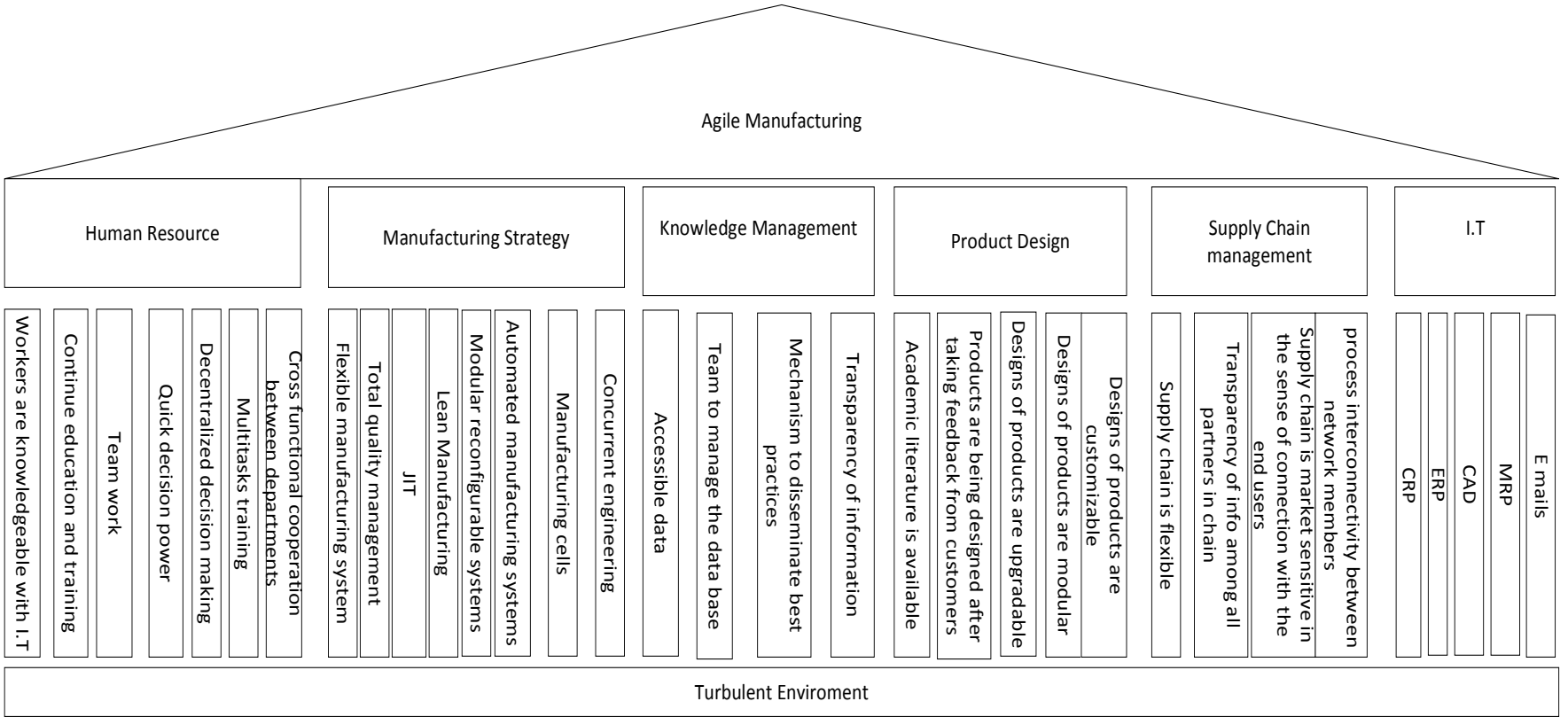

Figure-9. Agile Manufacturing Frame work

## 10. CONCLUSION

The literatures' richness of AM definition, concepts and enablers for large companies was highly visible, barely any attempt has been made to challenge the concepts' relevancy and applicability in the context of SMEs. Therefore purpose of this was to shed light on the AM concept itself and to scrutinize the concepts enablers suitable for SMEs, and thus companies with less financial resources than the large ones. The aim hereby was to challenge and to extend the existing body of knowledge not just by identifying the practices used by SMEs in the FAN industry in the quest to achieve high responsiveness, but also by providing a more practical approach gained from real-life examples. In coherence with this purpose, the main contribution of this paper is the creation of a model illustrating the AMs applied in SMEs in the FAN industry. Furthermore, this model will give other SMEs the possibility to reflect on their practices and to identify feasible areas of improvement.. Furthermore, it is crucial to recognize the AM concept, and also the created model within this thesis, as a guideline rather than a best-practice model applicable for each and every company and industry. The capability of the SMEs managers to create the right set of AMs relies strongly on their capability and willingness to perceive and act on change. Therefore, it is essential to pursue a continuous learning approach by constantly reflecting its own business processes and by being open-minded.

### Further Research

Considering the genuine interest in our research by the SMEs' managers from the FAN industry in Pakistan, it is believed that SMEs' AM deserves further investigations. As a matter of fact, the author of this paper is well aware of the generalizability issues raised in the methodology part. The choice made to focus on a single industry and a single country restrains the expandability of the conclusions. Therefore it would be interesting to compare the findings at a wider scope with a comparative analysis with different industries and perhaps different countries.

### REFERENCES

1. cook, J.K., *Agile Principles Unleashed: Proven Approaches for Achieving Real Productivity in Any Organisation*. Ely, U.K.: IT Governance Pub, 2010.
2. McCann J., S.J.a.L., *Building Agility, Resilience and Performance in Turbulent Environments*. people and strategy, 2009: p. 44-51.
3. Sherehiy, B., W. Karwowski, and J.K. Layer, A review of enterprise agility: concepts, frameworks, and attributes. *International Journal of Industrial Ergonomics*, 2007. 37(5): p. 445-460.
4. Vázquez-Bustelo, D., L. Avella, and E. Fernández, Agility drivers, enablers and outcomes: empirical test of an integrated agile manufacturing model. *International Journal of Operations & Production Management*, 2007. 27(12): p. 1303-1332.
5. Gunasekaran, A. and Y. Yusuf, Agile manufacturing: a taxonomy of strategic and technological imperatives. *International Journal of Production Research*, 2002. 40(6): p. 1357-1385.
6. Kidd, P., *Agile Manufacturing: Forging New Frontiers*. Wokingham, England. Reading, Massachussets, Addison-Wesley, 1994.
7. Christopher, M., *The agile supply chain: competing in volatile markets*. *Industrial marketing management*, 2000. 29(1): p. 37-44.
8. Frayret, J.-M., et al., A network approach to operate agile manufacturing systems. *International Journal of Production Economics*, 2001. 74(1): p. 239-259.
9. Kelly, K.L., et al., The optical properties of metal nanoparticles: the influence of size, shape, and dielectric environment. *The Journal of Physical Chemistry B*, 2003. 107(3): p. 668-677.
10. Corbett, L. and C. Campbell-Hunt, Grappling with a gusher! Manufacturing's response to business success in small and medium enterprises. *Journal of Operations Management*, 2002. 20(5): p. 495-517.
11. Goldman, S.L., R.N. Nagel, and K. Preiss, *Agile competitors and virtual organizations: strategies for enriching the customer*. Vol. 8. 1995: Van Nostrand Reinhold New York.
12. Power, D.J., A.S. Sohal, and S.-U. Rahman, Critical success factors in agile supply chain management-An empirical study. *International Journal of Physical Distribution & Logistics Management*, 2001. 31(4): p. 247-265.
13. Ribeiro, F.L. and M.T. Fernandes, Exploring agile methods in construction small and medium enterprises: a case study. *Journal of Enterprise Information Management*, 2010. 23(2): p. 161-180.
14. Ismail, H.S. and H. Sharifi, A balanced approach to building agile supply chains. *International Journal of Physical Distribution & Logistics Management*, 2006. 36(6): p. 431-444.
15. Krishnamurthy, R. and C.A. Yauch, Leagile manufacturing: a proposed corporate infrastructure. *International Journal of Operations & Production Management*, 2007. 27(6): p. 588-604.

16. Ramesh, G. and S. Devadasan, Literature review on the agile manufacturing criteria. *Journal of Manufacturing Technology Management*, 2007. 18(2): p. 182-201.
17. Jin-Hai, L., A.R. Anderson, and R.T. Harrison, The evolution of agile manufacturing. *Business Process Management Journal*, 2003. 9(2): p. 170-189.
18. Saxena, K. and B. Sahay, Managing IT for world-class manufacturing: the Indian scenario. *International Journal of Information Management*, 2000. 20(1): p. 29-57.
19. Cao, Q. and S. Dowlatshahi, The impact of alignment between virtual enterprise and information technology on business performance in an agile manufacturing environment. *Journal of Operations Management*, 2005. 23(5): p. 531-550.
20. Lee, T.H., *The design of CMOS radio-frequency integrated circuits* 2004: Cambridge university press.
21. Hormozi, A.M., Agile manufacturing: the next logical step. *Benchmarking: An International Journal*, 2001. 8(2): p. 132-143.
22. Kumar, A. and J. Motwani, A methodology for assessing time-based competitive advantage of manufacturing firms. *International Journal of Operations & Production Management*, 1995. 15(2): p. 36-53.
23. Sharifi, H. and Z. Zhang, Agile manufacturing in practice-Application of a methodology. *International Journal of Operations & Production Management*, 2001. 21(5/6): p. 772-794.
24. Inman, R.A., et al., Agile manufacturing: relation to JIT, operational performance and firm performance. *Journal of Operations Management*, 2011. 29(4): p. 343-355.
25. Gunasekaran, A., *Agile Manufacturing: The 21st Century Competitive Strategy: The 21st Century Competitive Strategy* 2001: Elsevier.
26. Sharifi, H. and Z. Zhang, A methodology for achieving agility in manufacturing organisations: An introduction. *International Journal of Production Economics*, 1999. 62(1): p. 7-22.
27. Breu, K., et al., Workforce agility: the new employee strategy for the knowledge economy. *Journal of Information Technology*, 2002. 17(1): p. 21-31.
28. Kathuria, R. and F.Y. Partovi, Work force management practices for manufacturing flexibility. *Journal of Operations Management*, 1999. 18(1): p. 21-39.
29. Christopher, M. and D. Towill, An integrated model for the design of agile supply chains. *International Journal of Physical Distribution & Logistics Management*, 2001. 31(4): p. 235-246.
30. Daghestani, S.F., *Design and Reconfiguration of Manufacturing Systems in Agile Manufacturing Environments*, 1998, Virginia Polytechnic Institute and State University.
31. Elkins, D.A., N. Huang, and J.M. Alden, Agile manufacturing systems in the automotive industry. *International Journal of Production Economics*, 2004. 91(3): p. 201-214.
32. Stratton, R. and R.D. Warburton, The strategic integration of agile and lean supply. *International Journal of Production Economics*, 2003. 85(2): p. 183-198.
33. Ben Naylor, J., M.M. Naim, and D. Berry, *Leagility: integrating the lean and agile manufacturing paradigms in the total supply chain*. *International Journal of Production Economics*, 1999. 62(1): p. 107-118.
34. Cagliano, R., F. Caniato, and G. Spina, Lean, agile and traditional supply: how do they impact manufacturing performance? *Journal of Purchasing and Supply Management*, 2004. 10(4): p. 151-164.
35. Commission, E., *The New SME Definition: User Guide and Model Declaration (2005)*. Available from: [http://europa.eu.int/comm/enterprise/enterprise\\_policy/sme\\_definition/sme\\_user\\_guide.pdf](http://europa.eu.int/comm/enterprise/enterprise_policy/sme_definition/sme_user_guide.pdf), 2005.
36. Modlin, I.M., et al., Gastroenteropancreatic neuroendocrine tumours. *The lancet oncology*, 2008. 9(1): p. 61-72.
37. Mason-Jones, R., B. Naylor, and D.R. Towill, Lean, agile or leagile? Matching your supply chain to the marketplace. *International Journal of Production Research*, 2000. 38(17): p. 4061-4070.
38. Stump, G.B., *An Integrated Framework for Applying Lean Manufacturing and Other Strategies in Mass Customization Environments*. 2008.
39. McCurry, L. and R. McIvor, Agile manufacturing: 21st century strategy for manufacturing on the periphery. *Irish Journal of Management*, 2002. 23(2): p. 75-93.
40. Nowakowska, B.A., et al., Severe mental retardation, seizures, and hypotonia due to deletions of MEF2C. *American Journal of Medical*

Genetics Part B: Neuropsychiatric Genetics, 2010. 153(5): p. 1042-1051.

41. Gunasekaran, A., E. Tirtiroglu, and V. Wolstencroft, An investigation into the application of agile manufacturing in an aerospace company. *Technovation*, 2002. 22(7): p. 405-415.
42. Brown, S. and J. Bessant, The manufacturing strategy-capabilities links in mass customisation and agile manufacturing—an exploratory study. *International Journal of Operations & Production Management*, 2003. 23(7): p. 707-730.
43. Laanti, M., O. Salo, and P. Abrahamsson, Agile methods rapidly replacing traditional methods at Nokia: A survey of opinions on agile transformation. *Information and Software Technology*, 2011. 53(3): p. 276-290.
44. Ismail, H., et al., How small and medium enterprises effectively participate in the mass customization game. *Engineering Management, IEEE Transactions on*, 2007. 54(1): p. 86-97.
45. Abdul-Nour, G., J. Drolet, and S. Lambert, Mixed production, flexibility and SME. *Computers & industrial engineering*, 1999. 37(1): p. 429-432.